



**HUMBLE FORGING LLP**  
ISO 9001:2015 Certified Precision Forging and CNC Machining Facility

# ANSI B16.5 Flanges





**HUMBLE FORGING LLP**  
ISO 9001:2015 Certified Precision Forging and CNC Machining Facility

# ANSI B16.5 Flanges







## TABLE OF CONTENTS

1.	Summary	4
2.	Class 150 Flanges	5
3.	Class 300 Flanges	7
4.	Class 400 Flanges	9
5.	Class 600 Flanges	11
6.	Class 900 Flanges	13
7.	Class 1500 Flanges	15
8.	Class 2500 Flanges	17
9.	Standard Finish	19
10.	Dimensional Tolerance Chart	20
11.	Dimensions of Flange Facings	21
12.	Thread Details	23
13.	Pipe Dimensions	24
14.	Material Grade	26
15.	Material Specifications	27
16.	Welding End	28
17.	Contact Us	29



## ANSI B16.5 Flanges

<b>Dimensions</b>	: ANSI B16.5
<b>Material Grades</b>	: Carbon Steel : ASTM / ASME A/SA 105 ASTM / ASME A 350 , ASTM A 181 LF 2 / A516 Gr.70 A36, A694 F42, F46, F52, F60, F65, F706. Alloy Steel : ASTM / ASME A/SA 182 & A 387 F1, F5, F9, F11, F12, F22, F91. Stainless Steel : ASTM A 182, A 240 F 304, 304L, 304H, 316, 316L, 316Ti, 310, 310S, 321, 321H, 317, 347, 347H, 904L Duplex & Super Duplex Steel : ASTM / ASME A/SA 182 F 44, F 45, F51, F 53, F 55, F 60, F 61. Copper Alloy : ASTM SB 61 , SB62 , SB151 , SB152 UNS No. C 70600 (Cu-Ni 90/10), C 71500 (Cu-Ni 70/30), UNS No. C 10100, 10200, 10300, 10800, 12000, 12200. Nickel Alloy : ASTM SB564, SB160, SB472, SB162 Nickel 200 (UNS No. N02200), Nickel 201 (UNS No. N02201), Monel 400 (UNS No. N04400), Monel 500 (UNS No. N05500), Inconel 800 (UNS No. N08800), Inconel 825 (UNS No. N08825), Inconel 600 (UNS No. N06600), Inconel 625 (UNS No. N06625), Inconel 601 (UNS No. N06601), Hastelloy C 276 (UNS No. N10276), Alloy 20 (UNS No. N08020).
<b>Class</b>	: 150, 300, 400, 600, 900, 1500, 2500.
<b>Size</b>	: 1/2" (15 NB) to 24" (600NB).
<b>Flange Face Type</b>	: Flate Face (FF), Raised Face (RF), Ring Type Joint (RTJ).

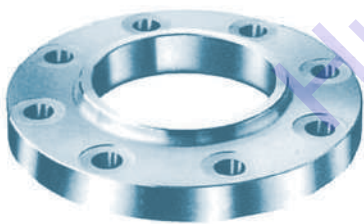

SLIP ON

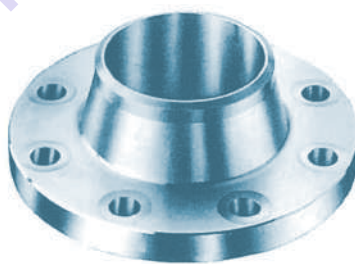

WELD NECK

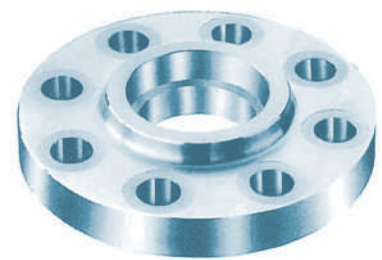

SOCKET WELD



THREADED



LAP JOINT

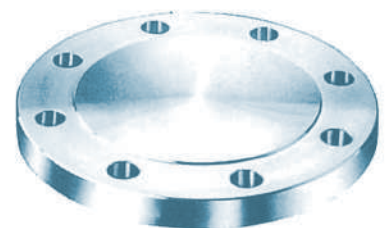

BLIND



## CLASS 150 FLANGES

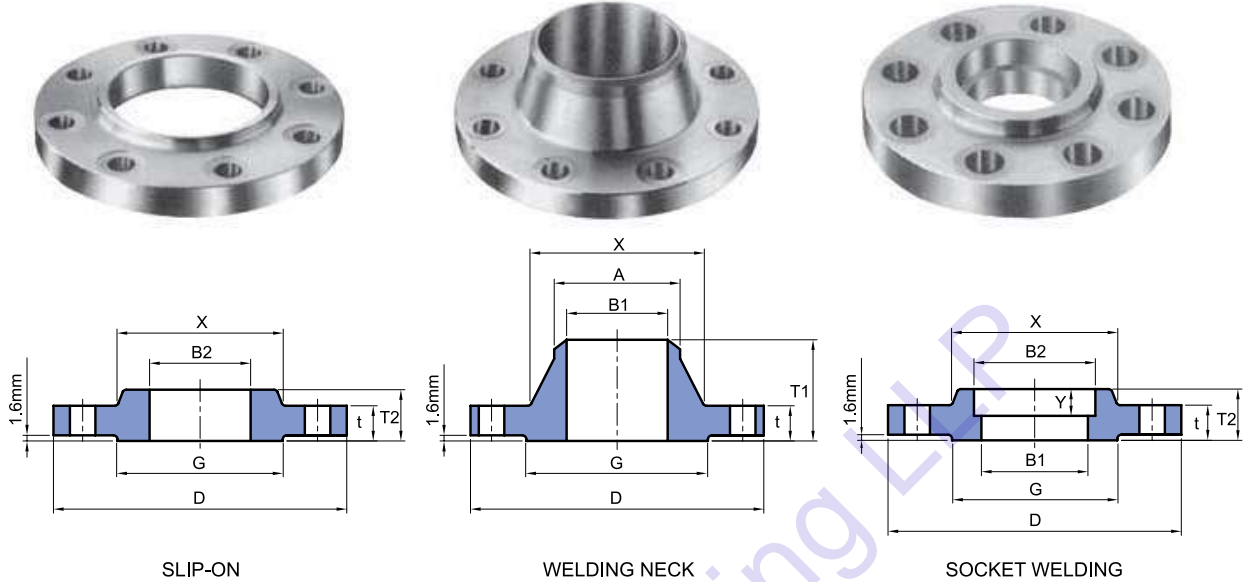

### ANSI B 16.5 Forged Flanges

Unit : mm

Nominal Pipe Size	Outside Diam.	Diam. at Base of Hub	O.D of Raised Face	Thickness	BORE			LENGTH THRU HUB			Diam. of Hub at Bevel	Radius of Fillet	Thread Length	Depth of Socket
					Welding Neck Socket Welding	Slip-on Socket Welding	Lap Joint	Welding Neck	Slip-on Threaded Socket Welding	Lap Joint				
	D	X	G	t	B1	B2	B3	T1	T2	T3	A	R	Q	Y
1/2	89	30.2	35.1	11.2	15.8	22.4	22.9	47.8	15.7	15.7	21.3	3.0	15.7	9.7
3/4	99	38.1	42.9	12.7	20.8	27.7	28.2	52.3	15.7	15.7	26.7	3.0	15.7	11.2
1	108	49.3	50.8	14.2	26.7	34.5	35.1	55.6	17.5	17.5	33.5	3.0	17.5	12.7
1 1/4	117	58.7	63.5	15.7	35.1	43.2	43.7	57.2	20.6	20.6	42.2	4.8	20.6	14.2
1 1/2	127	65.0	73.2	17.5	40.9	49.5	50.0	62.0	22.4	22.4	48.3	6.4	22.4	15.8
2	152	77.7	91.9	19.1	52.6	62.0	62.5	63.5	25.4	25.4	60.5	7.9	25.4	17.5
2 1/2	178	90.4	104.6	22.4	62.7	74.7	75.4	69.9	28.4	28.4	73.2	7.9	28.4	19.1
3	191	108.0	127.0	23.9	78.0	90.7	91.4	69.9	30.2	30.2	88.9	9.7	30.2	20.6
3 1/2	216	122.2	139.7	23.9	90.2	103.4	104.1	71.4	31.8	31.8	101.6	9.7	31.8	22.4
4	229	134.9	157.2	23.9	102.4	116.1	116.8	76.2	33.3	33.3	114.3	11.2	33.3	23.9
5	254	163.6	185.7	23.9	128.3	143.8	144.5	88.9	36.6	36.6	141.2	11.2	36.6	23.9
6	279	192.0	215.9	25.4	154.2	170.7	171.5	88.9	39.6	39.6	168.4	12.7	39.6	26.9
8	343	246.1	269.7	28.4	202.7	221.5	222.3	101.6	44.5	44.5	219.2	12.7	44.5	31.8
10	406	304.8	323.9	30.2	254.5	276.4	277.4	101.6	49.3	49.3	273.1	12.7	49.3	33.3
12	483	365.3	381.0	31.8	304.8	327.2	328.2	114.3	55.6	55.6	323.9	12.7	55.6	39.6
14	533	400.1	412.8	35.1	336.6	359.2	360.2	127.0	57.2	79.2	355.6	12.7	57.2	41.4
16	597	457.2	469.9	36.6	387.4	410.5	411.2	127.0	63.5	87.4	406.4	12.7	63.5	44.5
18	635	505.0	533.4	39.6	438.2	461.8	462.3	139.7	68.3	96.8	457.2	12.7	68.3	49.3
20	699	558.8	584.2	42.9	489.0	513.1	514.4	144.5	73.2	103.1	508.0	12.7	73.2	54.1
24	813	663.4	692.2	47.8	590.6	616.0	616.0	152.4	82.6	111.3	609.6	12.7	82.6	63.5

NOTE :

- For the 'Bore' (B1) other Standard Wall Thickness, refer to page 46,47
- Class 150 flanges except Lap Joint will be furnished with 0.06" (1.6mm) raised face, which is included in 'Thickness' (t) and 'Length through Hub' (T1), (T2).
- For Slip-on, Threaded, Socket Welding and Lap Joint Flanges, the hubs can be shaped either vertical from base to top or tapered within the limits of 7 degrees.



# HUMBLE FORGING LLP

ISO 9001:2015 Certified Precision Forging and CNC Machining Facility

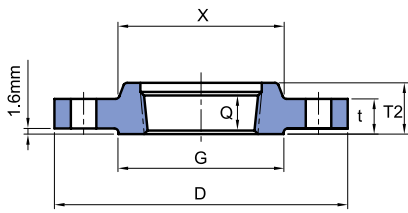

THREADED

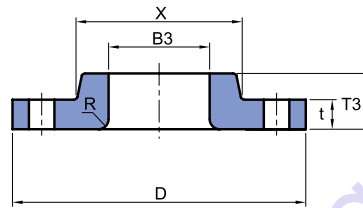

LAP JOINT

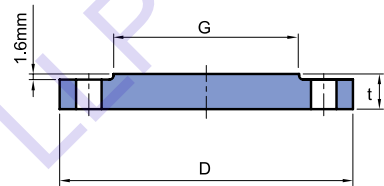

BLIND

Unit : mm

Nominal Pipe Size	DRILLING			BOLTING			APPROXIMATE WEIGHT										
	Bolt Circle Diam.	Number of Holes	Diam. of Holes	Diam. of Bolts (inch)	Machine Bolt Length	Stud Bolt Length		Welding Neck		Slip-on and Threaded		Lap Joint		Blind		Socket Welding	
						Raised Face	Ring Joint	Kg	lb	Kg	lb	Kg	lb	Kg	lb	Kg	lb
1/2	60.5	4	15.7	1/2	50.8	57.2	-	0.51	1.10	0.47	1.00	0.51	1.00	0.47	1.00	0.47	1.00
3/4	69.9	4	15.7	1/2	50.8	63.5	-	0.73	1.60	0.58	1.30	0.64	1.40	0.63	1.40	0.59	1.30
1	79.3	4	15.7	1/2	57.2	63.5	76.2	1.07	2.40	0.86	1.90	0.93	1.80	0.94	2.10	0.87	1.90
1 1/4	88.9	4	15.7	1/2	57.2	69.9	82.6	1.40	3.10	1.08	2.40	1.16	2.00	1.23	2.70	1.11	2.40
1 1/2	98.6	4	15.7	1/2	63.5	69.9	82.6	1.81	4.00	1.41	3.10	1.51	3.30	1.62	3.60	1.45	3.20
2	120.7	4	19.1	5/8	69.9	82.6	95.3	2.59	5.70	2.26	5.00	2.38	5.20	2.64	5.80	2.33	5.00
2 1/2	139.7	4	19.1	5/8	76.2	88.9	101.6	4.28	9.40	3.43	7.60	3.60	7.90	4.06	9.00	3.55	7.80
3	152.4	4	19.1	5/8	76.2	88.9	101.6	5.18	11.40	3.87	8.50	4.04	8.90	4.90	10.80	4.02	8.90
3 1/2	177.8	8	19.1	5/8	76.2	88.9	101.6	5.45	12.00	4.99	11.00	4.99	11.00	5.90	13.00	4.99	11.00
4	190.5	8	19.1	5/8	76.2	88.9	101.6	7.32	16.10	5.75	12.70	5.96	13.00	7.41	16.30	5.99	13.20
5	215.9	8	22.4	3/4	82.6	95.3	108.0	8.91	19.60	6.22	13.70	6.44	14.00	8.76	19.30	6.68	14.70
6	241.3	8	22.4	3/4	82.6	101.6	114.3	11.26	24.80	7.38	16.30	7.59	16.70	11.31	24.90	7.99	17.60
8	298.5	8	22.4	3/4	88.9	108.0	120.7	17.68	39.00	12.36	27.30	12.66	27.90	19.92	43.90	13.29	29.30
10	362.0	12	25.4	7/8	101.6	114.3	127.0	24.79	54.70	17.10	37.70	16.78	37.00	29.39	64.80	19.50	43.00
12	431.8	12	25.4	7/8	101.6	120.7	133.4	38.98	85.90	27.68	61.00	28.30	62.40	43.70	96.30	29.03	64.00
14	476.3	12	28.5	1	114.3	133.4	146.1	51.71	114.00	35.20	77.60	41.50	91.50	59.42	140.00	38.56	85.00
16	539.8	16	28.5	1	114.3	133.4	146.1	64.41	142.00	42.18	93.00	52.98	116.80	77.11	170.00	44.49	98.00
18	577.9	16	31.8	1 1/8	127.0	146.1	158.8	74.84	165.00	49.71	109.60	59.00	130.00	94.80	209.00	54.43	120.00
20	635.0	20	31.8	1 1/8	139.7	158.8	171.5	89.36	197.00	65.50	140.00	72.12	159.00	123.38	272.00	70.31	155.00
24	749.3	20	35.1	1 1/4	152.4	171.5	184.2	119.66	263.80	90.50	199.50	99.02	218.30	188.24	415.00	95.25	210.00

- Blind Flanges may be made with the same hub as that used for Slip-on Flanges or without hub.
- The gasket surface and backside (bearing surface for bolting) are made parallel within 1 degree. To accomplish parallelism, spot facing is carried out according to MSS SP-9, without reducing thickness (t).
- Depth of Socket (Y) is covered by ANSI B 16.5 only in sizes through 3 inch, over 3 inch is at the manufacturer's option.



## CLASS 300 FLANGES

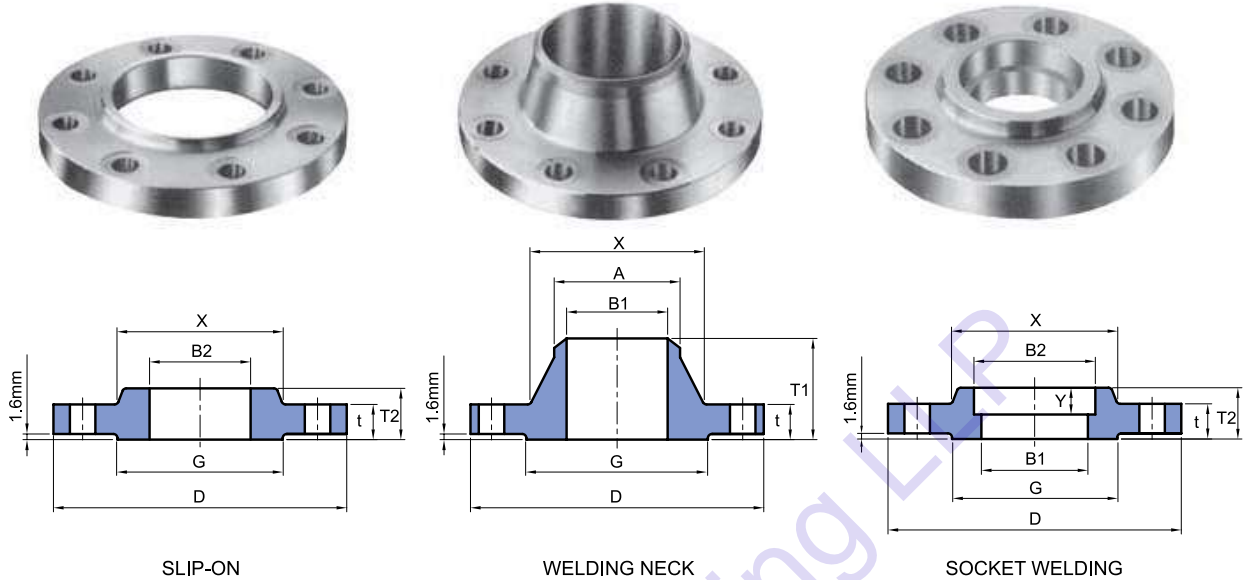

### ANSI B 16.5 Forged Flanges

Unit : mm

Nominal Pipe Size	Outside Diam.	Diam. at Base of Hub	O.D of Raised Face	Thickness	BORE				LENGTH THRU HUB			Diam. of Hub at Bevel	Radius of Fillet	Thread Length	Depth of Socket
					Welding Neck Socket Welding	Slip-on Socket Welding	Lap Joint	Counter Bore Min.	Welding Neck	Slip-on Threaded Socket Welding	Lap Joint				
					B1	B2	B3	B	T1	T2	T3				
1/2	95	38.1	35.1	14.2	15.7	22.4	22.9	23.6	52.3	22.4	22.4	21.3	3.0	15.7	9.7
3/4	117	47.8	42.9	15.7	20.8	27.7	28.2	29.0	57.2	25.4	25.4	26.7	3.0	15.7	11.2
1	124	53.8	50.8	17.5	26.7	34.5	35.1	35.8	62.0	26.9	26.9	33.5	3.0	17.5	12.7
1 1/4	133	63.5	63.5	19.1	35.1	43.2	43.7	44.5	65.0	26.9	26.9	42.2	4.8	20.6	14.2
1 1/2	155	69.9	73.2	20.6	40.9	49.5	50.0	50.5	68.3	30.2	30.2	48.3	6.4	22.4	15.7
2	165	84.1	91.9	22.4	52.6	62.0	62.5	63.5	69.9	33.3	33.3	60.5	7.9	28.4	17.5
2 1/2	191	100.1	104.6	25.4	62.7	74.7	75.4	76.2	76.2	38.1	38.1	73.2	7.9	31.8	19.1
3	210	117.3	127.0	28.4	78.0	90.7	91.4	92.2	79.2	42.9	42.9	88.9	9.7	31.8	20.6
3 1/2	229	133.4	139.7	30.2	90.2	103.4	104.1	104.9	81.0	44.5	44.5	101.6	9.7	36.6	22.4
4	254	146.1	157.2	31.8	102.4	116.1	116.8	117.6	85.9	47.8	47.8	114.3	11.2	36.6	23.9
5	279	177.8	185.7	35.1	128.3	143.8	144.5	144.5	98.6	50.8	50.8	141.2	11.2	42.9	23.9
6	318	206.2	215.9	36.6	154.2	170.7	171.5	171.5	98.6	52.3	52.3	168.4	12.7	46.0	26.9
8	381	260.4	269.7	41.1	202.7	221.5	222.3	222.3	111.3	62.0	62.0	219.2	12.7	50.8	31.8
10	445	320.5	323.9	47.8	254.5	276.4	277.4	276.4	117.3	66.5	95.3	273.1	12.7	55.6	33.3
12	521	374.7	381.0	50.8	304.8	327.2	328.2	328.7	130.0	73.2	101.6	323.9	12.7	60.5	39.6
14	584	425.5	412.8	53.8	336.6	359.2	360.2	360.4	142.7	76.2	111.3	355.6	12.7	63.5	41.4
16	648	482.6	469.9	57.2	387.4	410.5	411.2	411.2	146.1	82.6	120.7	406.4	12.7	68.3	44.5
18	711	533.4	533.4	60.5	438.2	461.8	462.3	462.0	158.8	88.9	130.0	457.2	12.7	69.9	49.3
20	775	587.2	584.2	63.5	489.0	513.1	514.4	512.8	162.1	95.3	139.7	508.0	12.7	73.2	54.1
24	914	701.5	692.2	69.9	590.6	616.0	616.0	614.4	168.1	106.4	152.4	609.6	12.7	82.6	63.5

NOTE :

- For the 'Bore' (B1) other Standard Wall Thickness, refer to page 46,47
- Class 300 flanges except Lap Joint will be furnished with 0.06" (1.6mm) raised face, which is included in 'Thickness' (t) and 'Length through Hub' (T1), (T2).
- For Slip-on, Threaded, Socket Welding and Lap Joint Flanges, the hubs can be shaped either vertical from base to top or tapered within the limits of 7 degrees.



# HUMBLE FORGING LLP

ISO 9001:2015 Certified Precision Forging and CNC Machining Facility

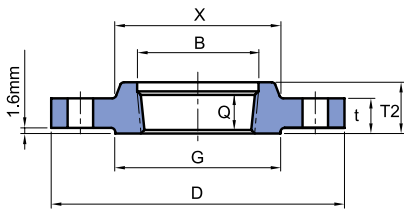

THREADED

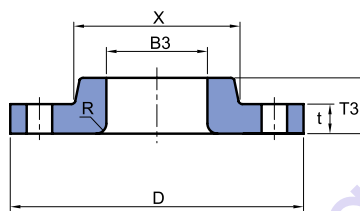

LAP JOINT

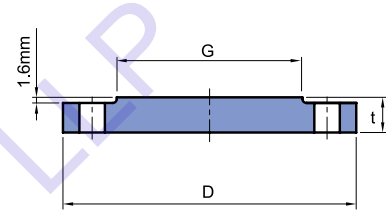

BLIND

Unit : mm

Nominal Pipe Size	DRILLING			BOLTING				APPROXIMATE WEIGHT									
	Bolt Circle Diam.	Number of Holes	Diam. of Holes	Diam. of Bolts (inch)	Machine Bolt Length	Stud Bolt Length		Welding Neck		Slip-on and Threaded		Lap Joint		Blind		Socket Welding	
						Raised Face	Ring Joint	Kg	lb	Kg	lb	Kg	lb	Kg	lb	Kg	lb
1/2	66.5	4	15.7	1/2	57.2	63.5	76.2	0.78	1.70	0.62	1.40	0.61	1.30	0.62	1.40	0.62	1.40
3/4	82.6	4	19.1	5/8	63.5	76.2	88.9	1.34	3.00	1.15	2.50	1.15	2.50	1.16	2.50	1.19	2.60
1	88.9	4	19.1	5/8	63.5	76.2	88.9	1.64	3.60	1.39	3.10	1.38	3.00	1.42	3.00	1.44	3.20
1 1/4	98.6	4	19.1	5/8	69.9	82.6	95.3	2.06	4.50	1.67	3.70	1.66	3.70	1.79	3.90	1.73	3.80
1 1/2	114.3	4	22.4	3/4	76.2	88.9	101.6	3.06	6.70	2.53	5.60	2.52	5.60	2.68	5.90	2.62	5.80
2	127.0	8	19.1	5/8	76.2	88.9	101.6	3.40	7.50	2.80	6.20	2.79	6.20	3.09	6.80	2.94	6.50
2 1/2	149.4	8	22.4	3/4	82.6	101.6	114.3	5.31	11.70	4.25	9.40	4.22	9.30	4.75	10.50	4.49	9.90
3	168.1	8	22.4	3/4	88.9	108.0	120.7	7.32	16.10	5.81	12.80	5.78	12.70	6.79	14.90	6.20	13.70
3 1/2	184.2	8	22.4	3/4	95.3	108.0	127.0	8.17	18.00	7.72	17.00	7.72	17.00	9.53	21.00	-	-
4	200.2	8	22.4	3/4	95.3	114.3	127.0	11.30	24.90	10.13	22.30	10.07	22.20	12.00	26.50	-	-
5	235.0	8	22.4	3/4	108.0	120.7	133.4	15.12	33.30	12.58	27.70	12.52	27.60	15.96	35.20	-	-
6	269.7	12	22.4	3/4	108.0	120.7	139.7	19.68	43.40	16.04	35.40	15.95	35.20	21.20	46.70	-	-
8	330.2	12	25.4	7/8	120.7	139.7	152.4	30.48	67.20	24.50	54.00	24.37	53.70	34.60	76.30	-	-
10	387.4	16	28.4	1	139.7	158.8	171.5	43.74	96.40	34.16	75.30	39.92	88.00	55.34	122.00	-	-
12	450.9	16	31.8	1 1/8	146.1	171.5	184.2	64.41	142.00	51.26	113.00	58.70	129.40	78.90	174.00	-	-
14	514.4	20	31.8	1 1/8	158.8	177.8	190.5	88.30	194.70	72.12	159.00	83.46	184.00	107.05	236.00	-	-
16	571.5	20	35.1	1 1/4	165.1	190.5	203.2	112.94	249.00	90.40	199.30	106.14	234.00	139.25	307.00	-	-
18	628.7	24	35.1	1 1/4	171.5	196.9	209.6	138.34	305.00	109.00	240.30	133.95	295.30	176.90	396.00	-	-
20	685.8	24	35.1	1 1/4	184.2	203.2	222.3	167.37	369.00	136.00	300.00	157.65	347.60	223.17	492.00	-	-
24	812.8	24	41.1	1 1/2	203.2	228.6	254.0	235.41	519.00	204.00	449.70	240.40	530.00	342.00	754.00	-	-

- Blind Flanges may be made with the same hub as that used for Slip-on Flanges or without hub.
- The gasket surface and backside (bearing surface for bolting) are made parallel within 1 degree. To accomplish parallelism, spot facing is carried out according to MSS SP-9, without reducing thickness (t).
- Depth of Socket (Y) is covered by ANSI B 16.5 only in sizes through 3 inch, over 3 inch is at the manufacturer's option.





## CLASS 400 FLANGES

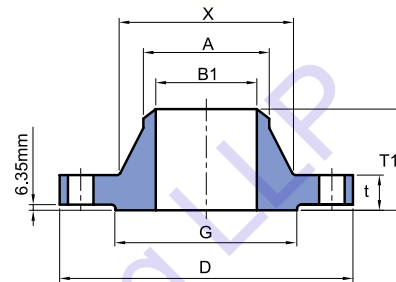
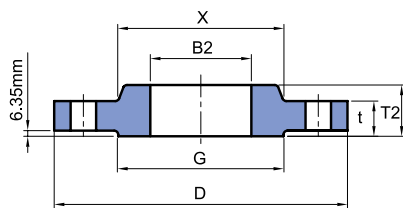

SLIP-ON

WELDING NECK

### ANSI B 16.5 Forged Flanges

Unit : mm

Nominal Pipe Size	Outside Diam.	Diam. at Base of Hub	O.D of Raised Face	Thickness	BORE				LENGTH THRU HUB			Diam. of Hub at Bevel	Radius of Fillet	Thread Length
					Welding Neck	Slip-on	Lap Joint	Counter Bore Min.	Welding Neck	Slip-on Threaded	Lap Joint			
	D	X	G	t	B1	B2	B3	B	T1	T2	T3	A	R	Q
1/2	95	38.1	35.1	14.2		22.4	22.9	23.6	52.3	22.4	22.4	21.3	3.0	15.7
3/4	117	47.8	42.9	15.7		27.7	28.2	29.0	57.2	25.4	25.4	26.7	3.0	15.7
1	124	53.8	50.8	17.5		34.5	35.1	35.8	62.0	26.9	26.9	33.5	3.0	17.5
1 1/4	133	63.5	63.5	20.6		43.2	43.7	44.5	66.5	28.4	28.4	42.2	4.8	20.6
1 1/2	155	69.9	73.2	22.4		49.5	50.0	50.5	69.9	31.8	31.8	48.3	6.4	22.4
2	165	84.1	91.9	25.4		62.0	62.5	63.5	73.2	36.6	36.6	60.5	7.9	28.4
2 1/2	191	100.1	104.6	28.4		74.7	75.4	76.2	79.2	41.1	41.1	73.2	7.9	31.8
3	210	117.3	127.0	31.8		90.7	91.4	92.2	82.6	46.0	46.0	88.9	9.7	35.1
3 1/2	229	133.4	139.7	35.1		103.4	104.1	104.9	85.9	49.3	49.3	101.6	9.7	39.6
4	254	146.1	157.2	35.1		116.1	116.8	117.6	88.9	50.8	50.8	114.3	11.2	36.6
5	279	177.8	185.7	38.1		143.8	144.5	144.5	101.6	53.8	53.8	141.2	11.2	42.9
6	318	206.2	215.9	41.1		170.7	171.5	171.5	103.1	57.2	57.2	168.4	12.7	46.0
8	381	260.4	269.7	47.8		221.5	222.3	222.3	117.3	68.3	68.3	219.2	12.7	50.8
10	445	320.5	323.9	53.8		276.4	277.4	276.4	124.0	73.2	101.6	273.1	12.7	55.6
12	521	374.7	381.0	57.2		327.2	328.2	328.7	136.7	79.2	108.0	323.9	12.7	60.5
14	584	425.5	412.8	60.5		359.2	360.2	360.4	149.4	84.1	117.3	355.6	12.7	63.5
16	648	482.6	469.9	63.5		410.5	411.2	411.2	152.4	93.7	127.0	406.4	12.7	68.3
18	711	533.4	533.4	66.5		461.8	462.3	462.0	165.1	98.6	136.7	457.2	12.7	69.9
20	775	587.2	584.2	69.9		513.1	514.4	512.8	168.1	101.6	146.1	508.0	12.7	73.2
24	914	701.5	692.2	76.2		616.0	616.0	614.4	174.8	114.3	158.8	609.6	12.7	82.6

NOTE :

- For the 'Bore' (B1) other Standard Wall Thickness, refer to page 46,47
- Class 400 flanges except Lap Joint will be furnished with 0.25" (6.35mm) raised face, which is included in 'Thickness' (t) and 'Length through Hub' (T1), (T2).
- For Slip-on, Threaded, Socket Welding and Lap Joint Flanges, the hubs can be shaped either vertical from base to top or tapered within the limits of 7 degrees.



# HUMBLE FORGING LLP

ISO 9001:2015 Certified Precision Forging and CNC Machining Facility

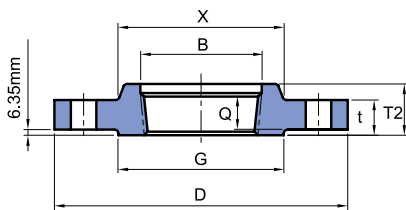

THREADED

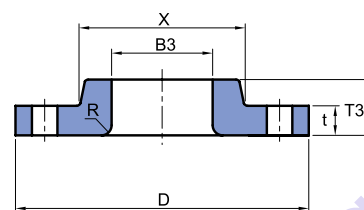

LAP JOINT

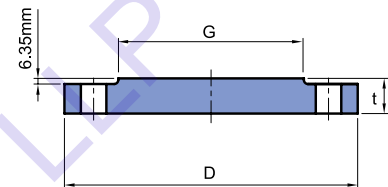

BLIND

Unit : mm

Nominal Pipe Size	DRILLING			BOLTING				APPROXIMATE WEIGHT							
	Bolt Circle Diam.	Number of Holes	Diam. of Holes	Diam. of Bolts (inch)	Stud Bolt Length			Welding Neck		Slip-on and Threaded		Lap Joint		Blind	
					0.25" Raised Face	Male-Female Tongue-Groove	Ring Joint	Kg	lb	Kg	lb	Kg	lb	Kg	lb
1/2	66.5	4	15.7	1/2	76.2	69.9	76.2	1.36	3.00	0.91	2.00	0.80	1.80	0.91	2.00
3/4	82.6	4	19.1	5/8	88.9	82.6	88.9	1.59	3.50	1.36	3.00	1.36	3.00	1.40	3.00
1	88.9	4	19.1	5/8	88.9	82.6	88.9	1.81	4.00	1.59	3.50	1.59	3.50	1.70	3.80
1 1/4	98.6	4	19.1	5/8	95.3	88.9	95.3	2.50	5.50	2.10	4.60	2.04	4.50	2.27	5.00
1 1/2	114.3	4	22.4	3/4	108.0	101.6	108.0	3.63	8.00	3.10	6.80	2.95	6.50	3.40	7.50
2	127.0	8	19.1	5/8	108.0	101.6	108.0	4.54	10.00	3.63	8.00	3.63	8.00	4.40	9.70
2 1/2	149.4	8	22.4	3/4	120.7	114.3	120.7	6.35	14.00	5.44	12.00	4.99	11.00	6.80	15.00
3	168.1	8	22.4	3/4	127.0	120.7	127.0	8.17	18.00	7.26	16.00	6.35	14.00	8.90	19.60
3 1/2	184.2	8	25.4	7/8	139.7	133.4	139.7	11.80	26.00	9.53	21.00	9.08	20.00	13.17	29.00
4	200.2	8	25.4	7/8	139.7	133.4	139.7	13.61	30.00	10.89	24.00	9.98	22.00	14.40	31.70
5	235.0	8	25.4	7/8	146.1	139.7	146.1	17.69	39.00	14.07	31.00	13.15	29.00	19.50	43.00
6	269.7	12	25.4	7/8	152.4	146.1	152.4	22.23	49.00	19.98	44.00	16.78	37.00	27.67	61.00
8	330.2	12	28.4	1	171.5	165.1	171.5	35.38	78.00	30.40	67.00	26.16	59.00	45.36	100.00
10	387.4	16	31.8	1 1/8	190.5	184.2	190.5	49.89	110.00	41.28	91.00	43.09	95.00	68.00	150.00
12	450.9	16	35.1	1 1/4	203.2	196.9	203.2	72.57	160.00	59.02	130.00	68.95	152.00	98.00	216.00
14	514.4	20	35.1	1 1/4	209.6	203.2	209.6	105.69	233.00	81.72	180.00	95.25	210.00	131.66	290.00
16	571.5	20	38.1	1 3/8	222.3	215.9	222.3	133.30	294.00	106.69	235.00	127.00	280.00	167.00	368.00
18	628.7	24	38.1	1 3/8	228.6	222.3	228.6	158.90	350.30	129.39	285.30	156.49	345.00	206.57	455.40
20	685.8	24	41.1	1 1/2	241.3	235.0	247.7	193.00	425.50	152.00	335.00	190.51	420.00	261.00	575.40
24	812.8	24	47.8	1 3/4	266.7	260.4	279.4	281.48	620.50	231.54	510.50	278.96	615.00	395.00	870.80

4. Blind Flanges may be made with the same hub as that used for Slip-on Flanges or without hub.
5. The gasket surface and backside (bearing surface for bolting) are made parallel within 1 degree. To accomplish parallelism, spot facing is carried out according to MSS SP-9, without reducing thickness (t).
6. Dimensions of size 1/2" through 3 1/2" are the same as for Class 600 Flanges.



## CLASS 600 FLANGES



### ANSI B 16.5 Forged Flanges

Unit : mm

Nominal Pipe Size	Outside Diam.	Diam. at Base of Hub	O.D of Raised Face	Thickness	BORE				LENGTH THRU HUB			Diam. of Hub at Bevel	Radius of Fillet	Thread Length	Depth of Socket
					Welding Neck Socket Welding	Slip-on Socket Welding	Lap Joint	Counter Bore Min.	Welding Neck	Slip-on Threaded Socket Welding	Lap Joint				
					B1	B2	B3	B	T1	T2	T3				
1/2	95	38.1	35.1	14.2		22.4	22.9	23.6	52.3	22.4	22.4	21.3	3.0	15.7	9.7
3/4	117	47.8	42.9	15.7		27.7	28.2	29.0	57.2	25.4	25.4	26.7	3.0	15.7	11.2
1	124	53.8	50.8	17.5		34.5	35.1	35.8	62.0	26.9	26.9	33.5	3.0	17.5	12.7
1 1/4	133	63.5	63.5	20.6		43.2	43.7	44.5	66.5	28.4	28.4	42.2	4.8	20.6	14.2
1 1/2	155	69.9	73.2	22.4		49.5	50.0	50.5	69.9	31.8	31.8	48.3	6.4	22.4	15.7
2	165	84.1	91.9	25.4		62.0	62.5	63.5	73.2	36.6	36.6	60.5	7.9	28.4	17.5
2 1/2	191	100.1	104.6	28.4		74.7	75.4	76.2	79.2	41.1	41.1	73.2	7.9	31.8	19.1
3	210	117.3	127.0	31.8		90.7	91.4	92.2	82.6	46.0	46.0	88.9	9.7	35.1	20.6
3 1/2	229	133.4	139.7	35.1		103.4	104.1	104.9	85.9	49.3	49.3	101.6	9.7	39.6	22.4
4	273	152.4	157.2	38.1		116.1	116.8	117.6	101.6	53.8	53.8	114.3	11.2	41.1	23.9
5	330	189.0	185.7	44.5		143.8	144.5	144.5	114.3	60.5	60.5	141.2	11.2	47.8	23.9
6	356	222.3	215.9	47.8		170.7	171.5	171.5	117.3	66.5	66.5	168.4	12.7	50.8	26.9
8	419	273.1	269.7	55.6		221.5	222.3	222.3	133.4	76.2	76.2	219.2	12.7	57.2	31.8
10	508	342.9	323.9	63.5		276.4	277.4	276.4	152.4	85.9	111.3	273.1	12.7	65.0	33.3
12	559	400.1	381.0	66.5		327.2	328.2	328.7	155.4	91.9	117.3	323.9	12.7	69.9	39.6
14	603	431.8	412.8	69.9		359.2	360.2	360.4	165.1	93.7	127.0	355.6	12.7	73.2	41.4
16	686	495.3	469.9	76.2		410.5	411.2	411.2	177.8	106.4	139.7	406.4	12.7	77.7	44.5
18	743	546.1	533.4	82.6		461.8	462.3	462.0	184.2	117.3	152.4	457.2	12.7	79.2	49.3
20	813	609.6	584.2	88.9		513.1	514.4	512.8	190.5	127.0	165.1	508.0	12.7	82.6	54.1
24	940	717.6	692.2	101.6		616.0	616.0	614.4	203.2	139.7	184.2	609.6	12.7	91.9	63.5

NOTE :

- For the 'Bore' (B1) other Standard Wall Thickness, refer to page 46,47
- Class 600 flanges except Lap Joint will be furnished with 0.25" (6.35mm) raised face, which is included in 'Thickness' (t) and 'Length through Hub' (T1), (T2).
- For Slip-on, Threaded, Socket Welding and Lap Joint Flanges, the hubs can be shaped either vertical from base to top or tapered within the limits of 7 degrees.



# HUMBLE FORGING LLP

ISO 9001:2015 Certified Precision Forging and CNC Machining Facility

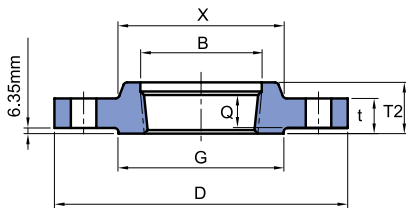

THREADED

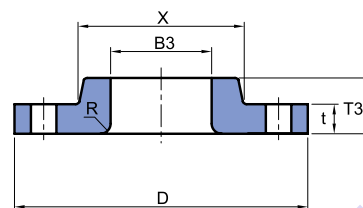

LAP JOINT

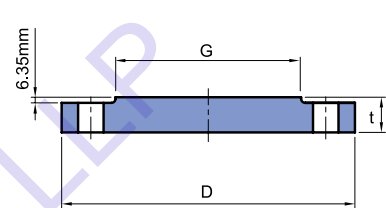

BLIND

Unit : mm

Nominal Pipe Size	DRILLING			BOLTING				APPROXIMATE WEIGHT									
	Bolt Circle Diam.	Number of Holes	Diam. of Holes	Diam. of Bolts (inch)	STUD BOLT LENGTH			Welding Neck		Slip-on and Threaded		Lap Joint		Blind		Socket Welding	
					0.25" Raised Face	Male - Female Tongue - Groove	Ring Joint	Kg	lb	Kg	lb	Kg	lb	Kg	lb	Kg	lb
1/2	66.5	4	15.7	1/2	76.2	69.9	76.2	0.90	2.00	0.91	2.00	0.80	1.80	0.91	2.00	0.91	2.00
3/4	82.6	4	19.1	5/8	88.9	82.6	88.9	1.59	3.50	1.40	3.00	1.36	3.00	1.40	3.00	1.36	3.00
1	88.9	4	19.1	5/8	88.9	82.6	88.9	1.90	4.00	1.70	3.70	1.59	3.50	1.81	4.00	1.81	4.00
1 1/4	98.6	4	19.1	5/8	95.3	88.9	95.3	2.49	5.50	2.27	5.00	2.04	4.50	2.40	5.30	2.60	5.70
1 1/2	114.3	4	22.4	3/4	108.0	101.6	108.0	3.63	8.00	3.10	6.80	2.95	6.50	3.40	7.50	3.18	7.00
2	127.0	8	19.1	5/8	108.0	101.6	108.0	4.54	10.00	3.63	8.00	3.63	8.00	4.40	9.70	3.90	8.60
2 1/2	149.4	8	22.4	3/4	120.7	114.3	120.7	6.35	14.00	5.44	12.00	4.99	11.00	6.80	15.00	5.90	13.00
3	168.1	8	22.4	3/4	127.0	120.7	127.0	8.16	18.00	7.26	16.00	6.35	14.00	8.90	19.60	7.40	16.30
3 1/2	184.2	8	25.4	7/8	139.7	133.4	139.7	11.80	26.00	9.53	21.00	9.08	20.00	13.17	29.00	-	-
4	215.9	8	25.4	7/8	146.1	139.7	146.1	16.78	37.00	14.97	33.00	14.06	31.00	18.60	41.00	-	-
5	266.7	8	28.4	1	165.1	158.8	165.1	30.87	68.00	28.50	62.80	27.50	60.60	30.84	68.00	-	-
6	292.1	12	28.4	1	171.5	165.1	171.5	36.77	80.00	36.32	80.00	35.38	78.00	38.00	83.80	-	-
8	349.3	12	31.8	1 1/8	190.5	184.2	196.9	50.80	112.00	44.00	97.00	50.80	112.00	62.20	137.00	-	-
10	431.8	16	35.1	1 1/4	215.9	209.6	215.9	86.26	190.00	76.20	168.00	74.00	163.00	102.00	224.90	-	-
12	489.0	20	35.1	1 1/4	222.3	215.9	222.3	102.51	226.00	97.52	215.00	108.86	240.00	132.00	291.00	-	-
14	527.1	20	38.1	1 3/8	235.0	228.6	235.0	121.56	268.00	102.00	224.80	111.00	244.70	158.00	348.30	-	-
16	603.3	20	41.1	1 1/2	254.0	247.7	254.0	177.06	290.00	149.82	330.20	165.71	365.30	224.73	495.40	-	-
18	654.1	20	44.5	1 5/8	273.1	266.7	273.1	215.65	475.40	180.10	412.30	194.00	427.70	285.00	628.30	-	-
20	723.9	24	44.5	1 5/8	285.8	279.4	292.1	267.86	590.50	231.54	510.50	258.78	570.50	365.00	804.70	-	-
24	838.2	24	50.8	1 7/8	330.2	323.9	336.6	372.00	820.00	330.00	725.50	362.00	798.00	533.45	1176.00	-	-

- Blind Flanges may be made with the same hub as that used for Slip-on Flanges or without hub.
- The gasket surface and backside (bearing surface for bolting) are made parallel within 1 degree. To accomplish parallelism, spot facing is carried out according to MSS SP-9, without reducing thickness (t).
- Dimensions of sizes 1/2" through 3 1/2" are the same as for Class 400 Flanges.
- Depth of Socket (Y) is covered by ANSI B 16.5 only in sizes through 3 inch, over 3 inch is at the manufacturer's option.





## CLASS 900 FLANGES

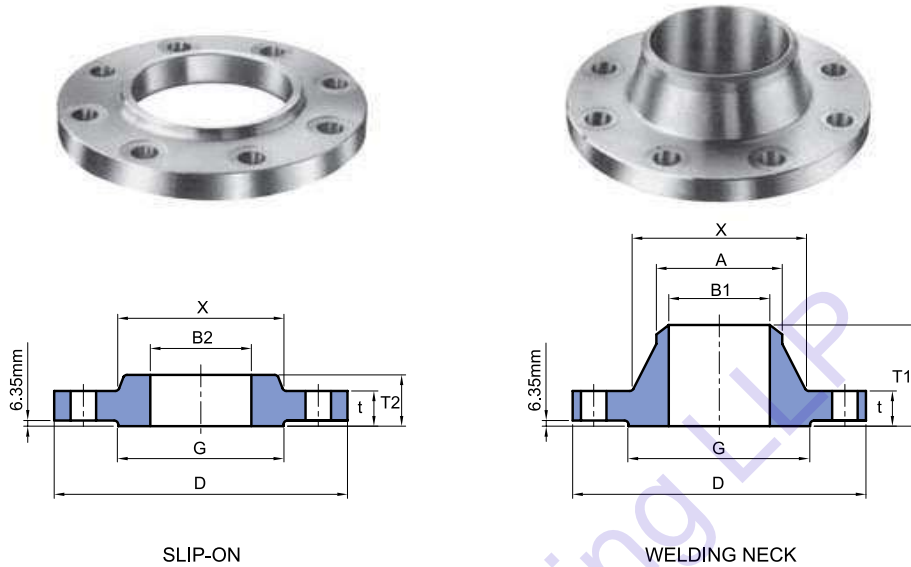

SLIP-ON

WELDING NECK

### ANSI B 16.5 Forged Flanges

Unit : mm

Nominal Pipe Size	Outside Diam.	Diam. at Base of Hub	O.D of Raised Face	Thickness	BORE				LENGTH THRU HUB			Diam. of Hub at Bevel	Radius of Fillet	Thread Length
					Welding Neck	Slip-on	Lap Joint	Counter Bore Min.	Welding Neck	Slip-on Threaded	Lap Joint			
	D	X	G	t	B1	B2	B3	B	T1	T2	T3	A	R	Q
1/2	121	38.1	35.1	22.4		22.4	22.9	23.6	60.5	31.8	31.8	21.3	3.0	22.4
3/4	130	44.5	42.9	25.4		27.7	28.2	29.0	69.9	35.1	35.1	26.7	3.0	25.4
1	149	52.3	50.8	28.4		34.5	35.1	35.8	73.2	41.1	41.1	33.5	3.0	28.4
1 1/4	159	63.5	63.5	28.4		43.2	43.7	44.5	73.2	41.1	41.1	42.2	4.8	30.2
1 1/2	178	69.9	73.2	31.8		49.5	50.0	50.5	82.6	44.5	44.5	48.3	6.4	31.8
2	216	104.6	91.9	38.1		62.0	62.5	63.5	101.6	57.2	57.2	60.5	7.9	38.1
2 1/2	244	124.0	104.6	41.1		74.7	75.4	76.2	104.6	63.5	63.5	73.2	7.9	47.8
3	241	127.0	127.0	38.1		90.7	91.4	92.2	101.6	53.8	53.8	88.9	9.7	41.1
4	292	158.8	157.2	44.5		116.1	116.8	117.6	114.3	69.9	69.9	114.3	11.2	47.8
5	349	190.5	185.7	50.8		143.8	144.5	144.5	127.0	79.2	79.2	141.2	11.2	53.8
6	381	235.0	215.9	55.6		170.7	171.5	171.5	139.7	85.9	85.9	168.4	12.7	57.2
8	470	298.5	269.7	63.5		221.5	222.3	222.3	162.1	101.6	114.3	219.2	12.7	63.5
10	546	368.3	323.9	69.9		276.4	277.4	276.4	184.2	108.0	127.0	273.1	12.7	71.4
12	610	419.1	381.0	79.2		327.2	328.2	328.7	200.2	117.3	142.7	323.9	12.7	76.2
14	641	450.9	412.8	85.9		359.2	360.2	360.4	212.9	130.0	155.4	355.6	12.7	82.6
16	705	508.0	469.9	88.9		410.5	411.2	411.2	215.9	133.4	165.1	406.4	12.7	85.9
18	787	565.2	533.4	101.6		461.8	462.3	462.0	228.6	152.4	190.5	457.2	12.7	88.9
20	857	622.3	584.2	108.0		513.1	514.4	512.8	247.7	158.8	209.6	508.0	12.7	91.9
24	1041	749.3	692.2	139.7		616.0	616.0	614.4	292.1	203.2	266.7	609.6	12.7	101.6

NOTE :

1. For the 'Bore' (B1) other Standard Wall Thickness, refer to page 46,47
2. Class 900 flanges except Lap Joint will be furnished with 0.25" (6.35mm) raised face, which is included in 'Thickness' (t) and 'Length through Hub' (T1), (T2).
3. For Slip-on, Threaded, Socket Welding and Lap Joint Flanges, the hubs can be shaped either vertical from base to top or tapered within the limits of 7 degrees.



# HUMBLE FORGING LLP

ISO 9001:2015 Certified Precision Forging and CNC Machining Facility

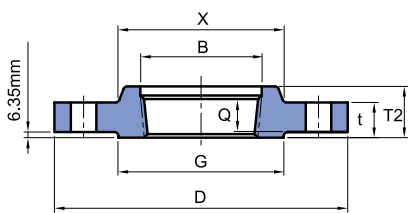

THREADED

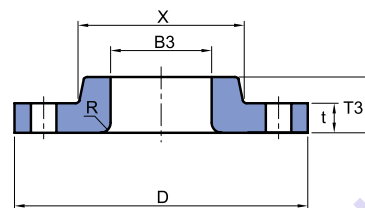

LAP JOINT

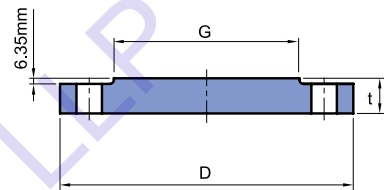

BLIND

Unit : mm

Nominal Pipe Size	DRILLING			BOLTING				APPROXIMATE WEIGHT							
	Bolt Circle Diam.	Number of Holes	Diam. of Holes	Diam. of Bolts (inch)	STUD BOLT LENGTH			Welding Neck		Slip-on and Threaded		Lap Joint		Blind	
					0.25" Raised Face	Male - Female Tongue - Groove	Ring Joint	Kg	lb	Kg	lb	Kg	lb	Kg	lb
1/2	82.6	4	22.4	3/4	108.0	101.6	108.0	2.10	4.60	1.81	4.00	1.81	4.00	1.90	4.20
3/4	88.9	4	22.4	3/4	114.3	108.0	114.3	2.72	6.00	2.40	5.30	2.30	5.00	2.70	6.00
1	101.6	4	25.4	7/8	127.0	120.7	127.0	3.86	8.50	3.41	7.50	3.40	7.50	4.09	9.00
1 1/4	111.3	4	25.4	7/8	127.0	120.7	127.0	4.54	10.00	4.10	9.00	4.09	9.00	4.54	10.00
1 1/2	124.0	4	28.4	1	139.7	133.4	139.7	5.90	13.00	5.45	12.00	5.40	11.90	5.90	13.00
2	165.1	8	25.4	7/8	146.1	139.7	146.1	10.89	24.00	9.98	22.00	9.53	21.00	11.34	25.00
2 1/2	190.5	8	28.4	1	158.8	152.4	158.8	16.33	36.00	15.80	34.80	13.15	29.00	16.00	35.30
3	190.5	8	25.4	7/8	146.1	139.7	146.1	15.00	33.00	11.80	26.00	11.34	25.00	13.17	29.00
4	235.0	8	31.8	1 1/8	171.5	165.1	171.5	23.13	51.00	23.20	51.00	22.60	48.50	24.50	54.00
5	279.4	8	35.1	1 1/4	190.5	184.2	190.5	38.50	84.90	37.65	83.00	36.74	81.00	39.46	87.00
6	317.5	12	31.8	1 1/8	190.5	184.2	196.9	49.89	110.00	48.30	106.50	47.50	104.70	51.50	113.50
8	393.7	12	38.1	1 3/8	222.3	215.9	222.3	79.45	175.00	75.00	166.30	86.00	189.60	89.00	106.20
10	469.9	16	38.1	1 3/8	235.0	228.6	235.0	118.04	260.00	111.13	245.00	125.64	277.00	131.54	290.00
12	533.4	20	38.1	1 3/8	254.0	247.7	254.0	157.00	346.00	146.00	321.80	167.00	368.00	187.00	412.30
14	558.8	20	41.1	1 1/2	273.1	266.7	279.4	181.60	400.40	172.36	380.00	180.07	397.00	224.07	494.00
16	616.0	20	44.5	1 5/8	285.8	279.4	292.1	224.73	495.50	192.95	425.40	211.11	465.40	272.40	600.50
18	685.8	20	50.8	1 7/8	323.9	317.5	336.6	308.72	680.60	272.40	600.50	295.10	650.60	385.90	850.80
20	749.3	20	53.8	2	349.3	342.9	362.0	376.82	830.70	331.42	730.60	367.74	810.70	488.00	1076.00
24	901.7	20	66.5	2 1/2	438.2	431.8	457.2	685.00	1510.00	632.00	1393.30	700.00	1543.00	905.00	1995.00

4. Blind Flanges may be made with the same hub as that used for Slip-on Flanges or without hub.

5. The gasket surface and backside (bearing surface for bolting) are made parallel within 1 degree. To accomplish parallelism, spot facing is carried out according to MSS SP-9, without reducing thickness (t).

6. Dimensions of size 1/2" through 2 1/2" are the same as for Class 1500 Flanges.



## CLASS 1500 FLANGES

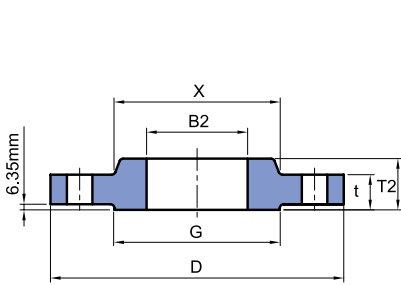

SLIP-ON

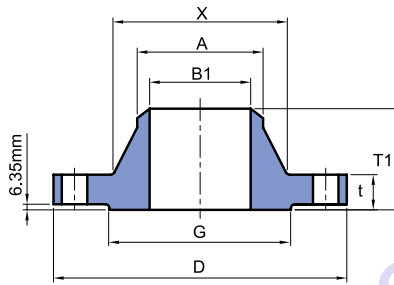

WELDING NECK

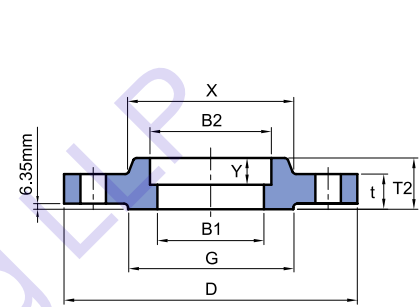

SOCKET WELDING

### ANSI B 16.5 Forged Flanges

Unit : mm

Nominal Pipe Size	Outside Diam.	Diam. at Base of Hub	O.D of Raised Face	Thickness	BORE				LENGTH THRU HUB			Diam. of Hub at Bevel	Radius of Fillet	Thread Length	Depth of Socket
					Welding Neck Socket Welding	Slip-on Socket Welding	Lap Joint	Counter Bore Min.	Welding Neck	Slip-on Threaded Socket Welding	Lap Joint				
					B1	B2	B3	B	T1	T2	T3				
1/2	121	38.1	35.1	22.4		22.4	22.9	23.6	60.5	31.8	31.8	21.3	3.0	22.4	9.7
3/4	130	44.5	42.9	25.4		27.7	28.2	29.0	69.9	35.1	35.1	26.7	3.0	25.4	11.2
1	149	52.3	50.8	28.4		34.5	35.1	35.8	73.2	41.1	41.1	33.5	3.0	28.4	12.7
1 1/4	159	63.5	63.5	28.4		43.2	43.7	44.5	73.2	41.1	41.1	42.2	4.8	30.2	14.2
1 1/2	178	69.9	73.2	31.8		49.5	50.0	50.5	82.6	44.5	44.5	48.3	6.4	31.8	15.7
2	216	104.6	91.9	38.1		62.0	62.5	63.5	101.6	57.2	57.2	60.5	7.9	38.1	17.5
2 1/2	244	124.0	104.6	41.1		74.7	75.4	76.2	104.6	63.5	63.5	73.2	7.9	47.8	19.1
3	267	133.4	127.0	47.8		90.7	91.4	92.2	117.3	73.2	73.2	88.9	9.7	50.8	20.6
4	311	162.1	157.2	53.8		116.1	116.8	117.6	124.0	90.4	90.4	114.3	11.2	57.2	23.9
5	375	196.9	185.7	73.2		143.8	144.5	144.5	155.4	104.6	104.6	141.2	11.2	63.5	23.9
6	394	228.6	215.9	82.6		170.7	171.5	171.5	171.5	119.1	119.1	168.4	12.7	69.9	26.9
8	483	292.1	269.7	91.9		221.5	222.3	222.3	212.9	142.7	142.7	219.2	12.7	76.2	31.8
10	584	368.3	323.9	108.0		276.4	277.4	276.4	254.0	158.8	177.8	273.1	12.7	84.1	33.3
12	673	450.9	381.0	124.0		327.1	328.2	328.7	282.4	180.8	218.9	323.9	12.7	91.9	39.6
14	749	495.3	412.8	133.4		359.2	360.2	360.4	298.5	-	241.3	355.6	12.7	-	41.4
16	826	552.5	469.9	146.1		410.5	411.2	411.2	311.2	-	260.4	406.4	12.7	-	44.5
18	914	596.9	533.4	162.1		461.8	462.3	462.0	327.2	-	276.4	457.2	12.7	-	49.3
20	984	641.4	584.2	177.8		513.1	514.4	512.8	355.6	-	292.1	508.0	12.7	-	54.1
24	1168	762.0	692.2	203.2		616.0	616.0	614.4	406.4	-	330.2	609.6	12.7	-	63.5

NOTE :

- For the 'Bore' (B1) other Standard Wall Thickness, refer to page 46,47
- Class 1500 flanges except Lap Joint will be furnished with 0.25" (6.35mm) raised face, which is included in 'Thickness' (t) and 'Length through Hub' (T1), (T2).
- For Slip-on, Threaded, Socket Welding and Lap Joint Flanges, the hubs can be shaped either vertical from base to top or tapered within the limits of 7 degrees.



# HUMBLE FORGING LLP

ISO 9001:2015 Certified Precision Forging and CNC Machining Facility

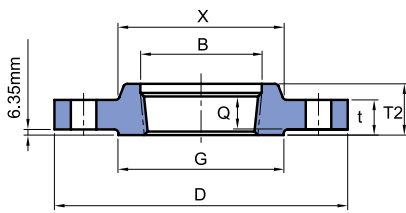

THREADED

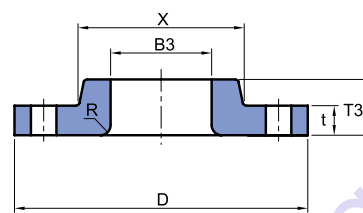

LAP JOINT

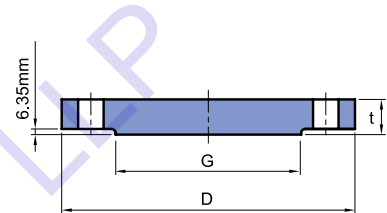

BLIND

Unit : mm

Nominal Pipe Size	DRILLING			BOLTING				APPROXIMATE WEIGHT									
	Bolt Circle Diam.	Number of Holes	Diam. of Holes	Diam. of Bolts (inch)	STUD BOLT LENGTH			Welding Neck		Slip-on and Threaded		Lap Joint		Blind		Socket Welding	
					0.25" Raised Face	Male - Female Tongue - Groove	Ring Joint	Kg	lb	Kg	lb	Kg	lb	Kg	lb	Kg	lb
1/2	82.6	4	22.4	3/4	108.0	101.6	108.0	2.10	4.60	1.80	4.00	1.80	4.00	1.90	4.00	1.81	4.00
3/4	88.9	4	22.4	3/4	114.3	108.0	114.3	2.72	6.00	2.27	5.00	2.27	5.00	2.72	6.00	2.81	6.20
1	101.6	4	25.4	7/8	127.0	120.7	127.0	3.86	8.50	3.40	7.50	3.40	7.50	4.08	9.00	3.61	8.00
1 1/4	111.3	4	25.4	7/8	127.0	120.7	127.0	4.54	10.00	4.10	9.00	4.09	10.80	4.30	9.50	4.99	11.00
1 1/2	124.0	4	28.4	1	139.7	133.4	139.7	5.90	13.00	5.45	12.00	5.40	11.90	5.90	13.00	6.76	14.90
2	165.1	8	25.4	7/8	146.1	139.7	146.1	10.89	24.00	10.50	23.00	9.53	21.00	11.30	25.00	10.89	24.00
2 1/2	190.5	8	28.4	1	158.8	152.4	158.8	16.34	36.00	15.80	34.80	13.15	29.00	16.00	35.30	16.34	36.00
3	203.2	8	31.8	1 1/8	177.8	171.5	177.8	21.79	48.00	21.77	48.00	17.24	38.00	21.79	48.00	-	-
4	241.3	8	35.1	1 1/4	196.9	190.5	196.9	31.30	69.00	31.00	68.40	29.00	63.90	33.11	73.00	-	-
5	292.1	8	41.1	1 1/2	247.7	241.3	247.7	59.02	130.00	58.80	129.60	54.00	119.00	60.00	132.30	-	-
6	317.5	12	38.1	1 3/8	260.4	254.0	266.7	74.91	165.00	74.00	163.00	62.00	136.70	75.00	165.30	-	-
8	393.7	12	44.5	1 5/8	292.1	285.8	323.9	123.83	273.00	117.73	258.00	129.73	236.00	136.98	302.00	-	-
10	482.6	12	50.8	1 7/8	336.6	330.2	342.9	205.93	454.00	197.49	435.40	220.19	485.40	229.97	507.00	-	-
12	571.5	16	53.8	2	374.7	368.3	387.4	306.00	674.60	264.00	582.00	286.02	630.60	316.00	696.70	-	-
14	635.0	16	60.5	2 1/4	406.4	400.1	425.5	416.00	917.00	-	-	404.06	890.80	421.00	928.00	-	-
16	704.9	16	66.5	2 1/2	444.5	438.2	469.9	567.50	1250.00	-	-	522.10	1151.00	559.00	1232.70	-	-
18	774.7	16	73.2	2 3/4	495.3	489.0	527.1	736.00	1622.60	-	-	669.65	1476.30	761.00	1677.70	-	-
20	831.9	16	79.2	3	539.8	533.4	565.2	929.00	2048.00	-	-	805.85	1776.60	967.00	2131.80	-	-
24	990.6	16	91.9	3 1/2	616.0	609.6	647.7	1504.00	3315.70	-	-	1285.55	2834.00	1568.00	3456.80	-	-

- Blind Flanges may be made with the same hub as that used for Slip-on Flanges or without hub.
- The gasket surface and backside (bearing surface for bolting) are made parallel within 1 degree. To accomplish parallelism, spot facing is carried out according to MSS SP-9, without reducing thickness (t).
- Dimensions of sizes 1/2" through 2 1/2" are the same as for Class 900 Flanges.
- Depth of Socket (Y) is covered by ANSI B 16.5 only in sizes through 2 1/2 inch, over 2 1/2 inch is at the manufacturer's option.





## CLASS 2500 FLANGES

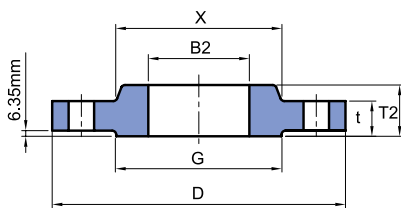

SLIP-ON

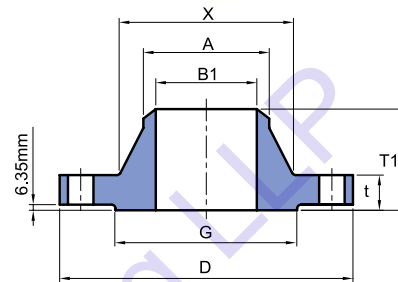

WELDING NECK

### ANSI B 16.5 Forged Flanges

Unit : mm

Nominal Pipe Size	Outside Diam.	Diam. at Base of Hub	O.D of Raised Face	Thickness	BORE				LENGTH THRU HUB			Diam. of Hub at Bevel	Radius of Fillet	Thread Length
					Welding Neck	Slip-on	Lap Joint	Counter Bore Min.	Welding Neck	Slip-on Threaded	Lap Joint			
	D	X	G	t	B1	B2	B3	B	T1	T2	T3	A	R	Q
1/2	133	42.9	35.1	30.2	To be specified by purchaser.	22.4	22.9	23.6	73.2	39.6	39.6	21.3	3.0	28.4
3/4	140	50.8	42.9	31.8		27.7	28.2	29.0	79.2	42.9	42.9	26.7	3.0	31.8
1	159	57.2	50.8	35.1		34.5	35.1	35.8	88.9	47.8	47.8	33.5	3.0	35.1
1 1/4	184	73.2	63.5	38.1		43.2	43.7	44.5	95.3	52.3	52.3	42.2	4.8	38.1
1 1/2	203	79.2	73.2	44.5		49.5	50.0	50.5	111.3	60.5	60.5	48.3	6.4	44.5
2	235	95.3	91.9	50.8		62.0	62.5	63.5	127.0	69.9	69.9	60.5	7.9	50.8
2 1/2	267	114.3	104.6	57.2		74.7	75.4	76.2	142.7	79.2	79.2	73.2	7.9	57.2
3	305	133.4	127.0	66.5		90.7	91.4	92.2	168.1	91.9	91.9	88.9	9.7	63.5
4	356	165.1	157.2	76.2		116.1	116.8	117.6	190.5	108.0	108.0	114.3	11.2	69.9
5	419	203.2	185.7	91.9		143.8	144.5	144.5	228.6	130.0	130.0	141.2	11.2	76.2
6	483	235.0	215.9	108.0		170.7	171.5	171.5	273.1	152.4	152.4	168.4	12.7	82.6
8	552	304.8	269.7	127.0		221.5	222.3	222.3	317.5	177.8	177.8	219.2	12.7	95.3
10	673	374.7	323.9	165.1	276.4	277.4	276.4	419.1	228.6	228.6	273.1	12.7	108.0	
12	762	441.5	381.0	184.2	327.2	328.2	328.7	463.6	254.0	254.0	323.9	12.7	120.7	

NOTE :

1. For the 'Bore' (B1) other Standard Wall Thickness, refer to page 46,47
2. Class 2500 flanges except Lap Joint will be furnished with 0.25" (6.35mm) raised face, which is included in 'Thickness' (t) and 'Length through Hub' (T1), (T2).
3. For Slip-on, Threaded, Socket Welding and Lap Joint Flanges, the hubs can be shaped either vertical from base to top or tapered within the limits of 7 degrees.



# HUMBLE FORGING LLP

ISO 9001:2015 Certified Precision Forging and CNC Machining Facility

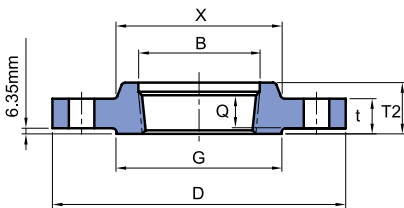

THREADED

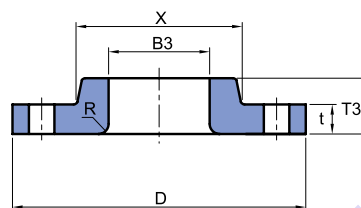

LAP JOINT

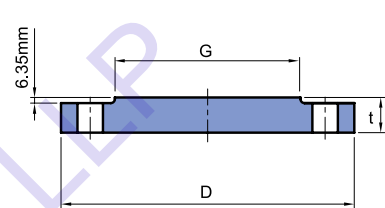

BLIND

Unit : mm

Nominal Pipe Size	DRILLING			BOLTING				APPROXIMATE WEIGHT							
	Bolt Circle Diam.	Number of Holes	Diam. of Holes	Diam. of Bolts (inch)	STUD BOLT LENGTH			Welding Neck		Slip-on and Threaded		Lap Joint		Blind	
					0.25" Raised Face	Male - Female Tongue - Groove	Ring Joint	Kg	lb	Kg	lb	Kg	lb	Kg	lb
1/2	88.9	4	22.4	3/4	120.7	114.3	120.7	3.18	7.00	3.18	7.00	3.00	6.60	3.18	7.00
3/4	95.3	4	22.4	3/4	127.0	120.7	127.0	4.08	9.00	4.08	9.00	3.63	8.00	4.54	10.00
1	108.0	4	25.4	7/8	139.7	133.4	139.7	5.45	12.00	5.44	12.00	4.99	11.00	5.44	12.00
1 1/4	130.0	4	28.4	1	152.4	146.1	152.4	9.07	20.00	8.16	18.00	7.26	16.00	8.16	18.00
1 1/2	146.1	4	31.8	1 1/8	171.5	165.1	171.5	11.35	25.00	11.00	24.30	9.99	22.00	10.44	23.00
2	171.5	8	28.4	1	177.8	171.5	177.8	19.07	42.00	17.25	38.00	16.80	37.00	17.71	39.00
2 1/2	196.9	8	31.8	1 1/8	196.9	190.5	203.2	23.61	52.00	24.97	55.00	24.06	53.00	25.42	56.00
3	228.6	8	35.1	1 1/4	222.3	215.9	228.6	42.68	94.00	37.68	83.00	36.32	80.00	39.04	86.00
4	273.1	8	41.1	1 1/2	254.0	247.7	260.4	64.00	141.00	58.00	127.90	54.48	120.00	60.38	133.00
5	323.9	8	47.8	1 3/4	298.5	292.1	311.2	110.68	244.00	95.25	210.00	92.53	204.00	101.15	223.00
6	368.3	8	53.8	2	342.9	336.6	355.6	176.46	378.00	146.51	323.00	143.01	315.30	156.63	345.30
8	438.2	12	53.8	2	381.0	374.7	393.7	261.27	576.00	219.99	485.00	213.38	470.40	240.62	530.50
10	539.8	12	66.5	2 1/2	489.0	482.6	508.0	484.43	1068.00	419.57	925.00	408.60	900.80	465.36	1026.00
12	619.3	12	73.2	2 3/4	539.8	533.4	558.8	692.35	1526.30	590.20	1301.00	572.95	1263.00	664.06	1464.00

- Blind Flanges may be made with the same hub as that used for Slip-on Flanges or without hub.
- The gasket surface and backside (bearing surface for bolting) are made parallel within 1 degree. To accomplish parallelism, spot facing is carried out according to MSS SP-9, without reducing thickness (t).
- Class 2500 Slip-on Flanges are not covered by ANSI B16.5, slip-on flanges are at the manufacture's option.

## STANDARD FINISH

### STANDARD FINISHES for Face of Flange (ANSI B16.5)

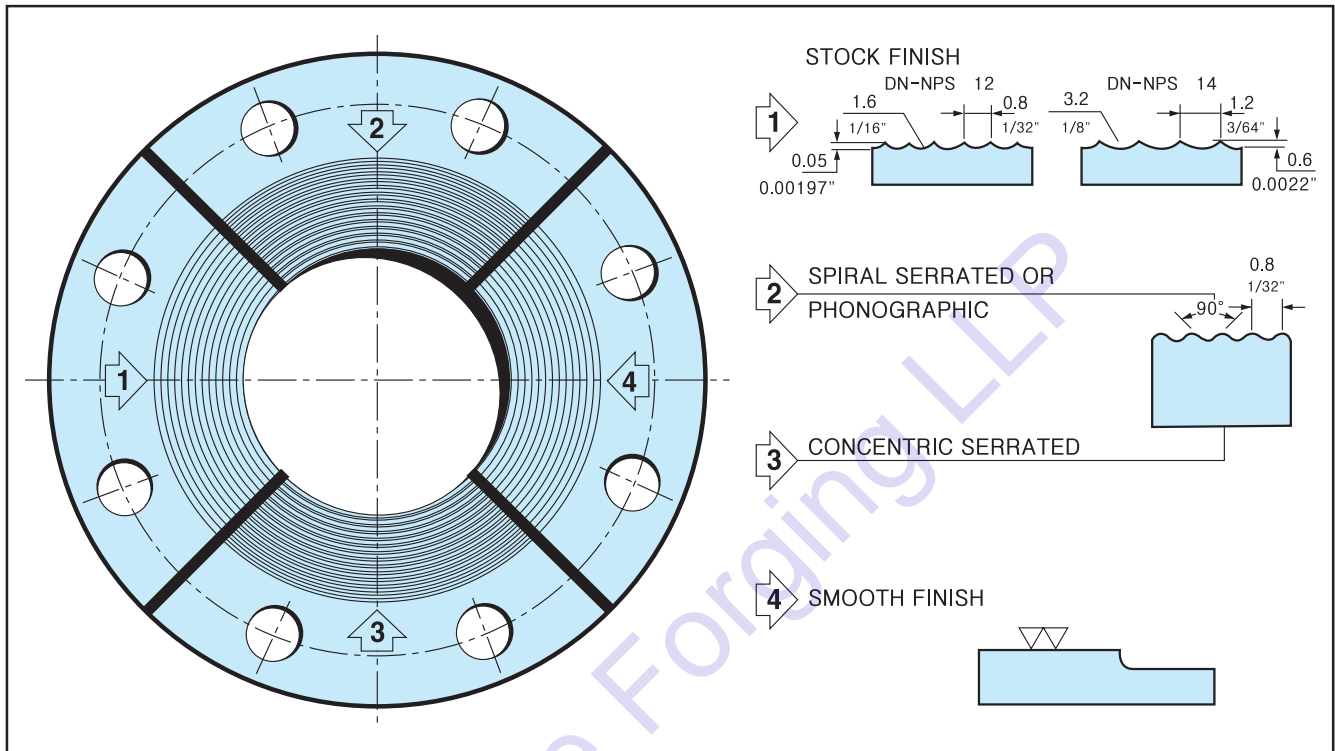

**STOCK FINISH** : The most widely used of any gasket finish, because practically, is suitable for all ordinary service conditions. This is a continuous spiral groove. Flanges sizes 12" (304.8mm) and smaller are produced with a 1/16" round-nosed tool at a feed of 1/32" per revolution. For sizes 14" (355.6mm) and larger, the finish is made with 1/8" round-nosed tool at a feed of 3/64" per revolution.

**SPIRAL SERRATED OR PHONOGRAPHIC** : This finish is produced by using a 90° round-nosed tool.

**CONCENTRIC SERRATED** : This finish is produced by using a 90° round-nosed tool.

**SMOOTH FINISH** : The cutting tool employed shall have an approximate 0.06" radius. The resultant surface finish shall have a 125μ inch to 250μ inch (ANSI B16.5 para 6.4, 4.1)

#### 1. RAISED FACE, AND LARGE MALE AND FEMALE

Either a serrated-concentric or serrated-spiral finish having from 45 to 55 grooves per inch is used. The cutting tool employed has an approximate 0.06 in radius. The resultant surface finish shall have a 125μ inch (3.2μ) to 250μ inch (6.4μm) approximate roughness.

#### 2. TONGUE AND GROOVE, AND SMALL MALE AND FEMALE

The gasket contact surface does not exceed 125μ in (3.2μm) roughness.

#### 3. RING JOINT

The inside wall surface of gasket groove does not exceed 63μ in (1.6μm) roughness.

#### 4. BLIND

Blind flanges need not be faced in the center if when this center part is raised its diameter is at least 1 in. smaller than the inside diameter of fittings of the corresponding pressure class. When the center part is depressed, its diameter is not greater than the inside diameter of the corresponding pressure class fittings. Machining of the depressed center is not required.



## TOLERANCE

### ANSI B16.5 FORGED FLANGES

SOLID FLANGE

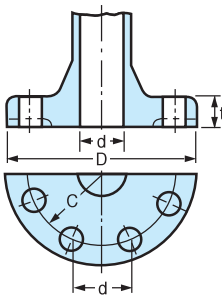

SLIP-ON FLANGE

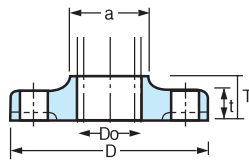

WELDING NECK FLANGE

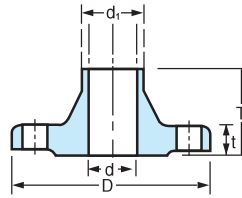

TYPE OF GASKET SURFACE

MALE & FEMALE TYPE

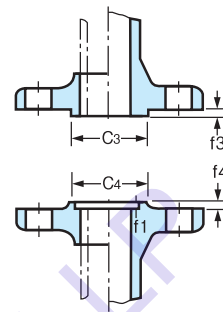

TONGUE & GROOVE TYPE

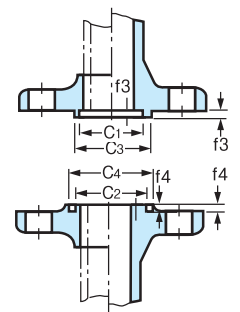

### THREAD, SOCKET-WELDING, SLIP-ON, LAP JOINT AND BLIND.

Outside Diameter	When O.D. is 24" or less	$\pm 1/16"$ (1.6mm)*
	When O.D. is Over 24"	$\pm 1/8"$ (3.2mm)*
Inside Diameter	Threaded	Within limits on boring gauge
	Socket-Welding, Slip-on and Lap joint	10" & Smaller $+1/32"$ (0.8mm), 0" 12" & Larger $+1/16"$ (1.6mm), 0"
Outside Diameter of Hub	5" and Smaller	$+3/32"$ (2.4mm)* $-1/32"$ (0.8mm)
	6" and Larger	$+5/32"$ (4.0mm) $-1/32"$ (0.8mm)
Diameter of Contact Face	1/16" Raised Face	$\pm 1/32"$ (0.8mm)
	1/4" Raised Face Tongue & Groove Male, Female	$\pm 1/64"$ (0.4mm)
Diameter of Counterbore	Same as for Inside Diameter	
Drilling	Bolt Circle	$\pm 1/16"$ (1.6mm)
	Bolt Hole Spacing	$\pm 1/32"$ (0.8mm)
	Eccentricity of Bolt Circle with Respect to Facing	2 1/2" Smaller $1/32"$ (0.8mm) Max. 3" & Larger $1/16"$ (1.6mm) Max.
	Eccentricity of Bolt Circle with Respect to bore	$1/32"$ (0.8mm) Max.*
	Eccentricity of Facing with Respect to Bore	$1/32"$ (0.8mm) Max.*
Thickness	18" and Smaller	$+1/8"$ (3.2mm), -0"
	20" and Larger	$+3/16"$ (4.8mm), -0"
Length Thru Hub	10" and Smaller	$\pm 1/16"$ (1.6mm)
	12" and Larger	$\pm 1/8"$ (3.2mm)

### WELDING NECK

Outside Diameter	When O.D. is 24" or Less	$\pm 1/16"$ (1.6mm)*
	When O.D. is Over 24"	$\pm 1/8"$ (3.2mm)*
Inside Diameter	10" and Smaller	$\pm 1/32"$ (0.8mm)
	12" thru 18"	$\pm 1/16"$ (1.6mm)
	20" and Larger	$+1/8"$ (3.2mm) $-1/16"$ (1.6mm)
Diameter of Contact Face	1/16" Raised Face	$\pm 1/32"$ (0.8mm)
	1/4" Raised Face Tongue & Groove Male, Female	$\pm 1/64"$ (0.4mm)
Diameter of Hub at Base	When Hub Base is 24" or Smaller	$\pm 1/16"$ (1.6mm)*
	When Hub Base is Over 24"	$\pm 1/8"$ (3.2mm)*
Diameter of Hub at Point of Welding	5" and Smaller	$+3/32"$ (2.4mm) $-1/32"$ (0.8mm)
	6" and Larger	$+5/32"$ (4.0mm) $1/32"$ (0.8mm)
Drilling	Bolt Circle	$\pm 1/16"$ (1.6mm)
	Bolt Hole Spacing	$\pm 1/32"$ (0.8mm)
	Eccentricity of Bolt Circle with Respect to Facing	2 1/2" & Smaller $1/32"$ (0.8mm) Max. 3" & Larger $1/16"$ (1.6mm) Max.
	Eccentricity of Bolt Circle with Respect to Bore	$1/32"$ (0.8mm) Max.*
	Eccentricity of Facing with Respect to Bore	$1/32"$ (0.8mm) Max.*
Thickness	18" and Smaller	$+1/8"$ (3.2mm), -0"
	20" and Larger	$+3/16"$ (4.8mm), -0"
Length Thru Hub	10" and Smaller	$\pm 1/16"$ (1.6mm)
	12" and Larger	$\pm 1/8"$ (3.2mm)

**Note:** \*This tolerance is not covered in ANSI B16.5, but maker's option.





## FLANGES FACINGS

### DIMENSIONS OF FLANGE FACINGS

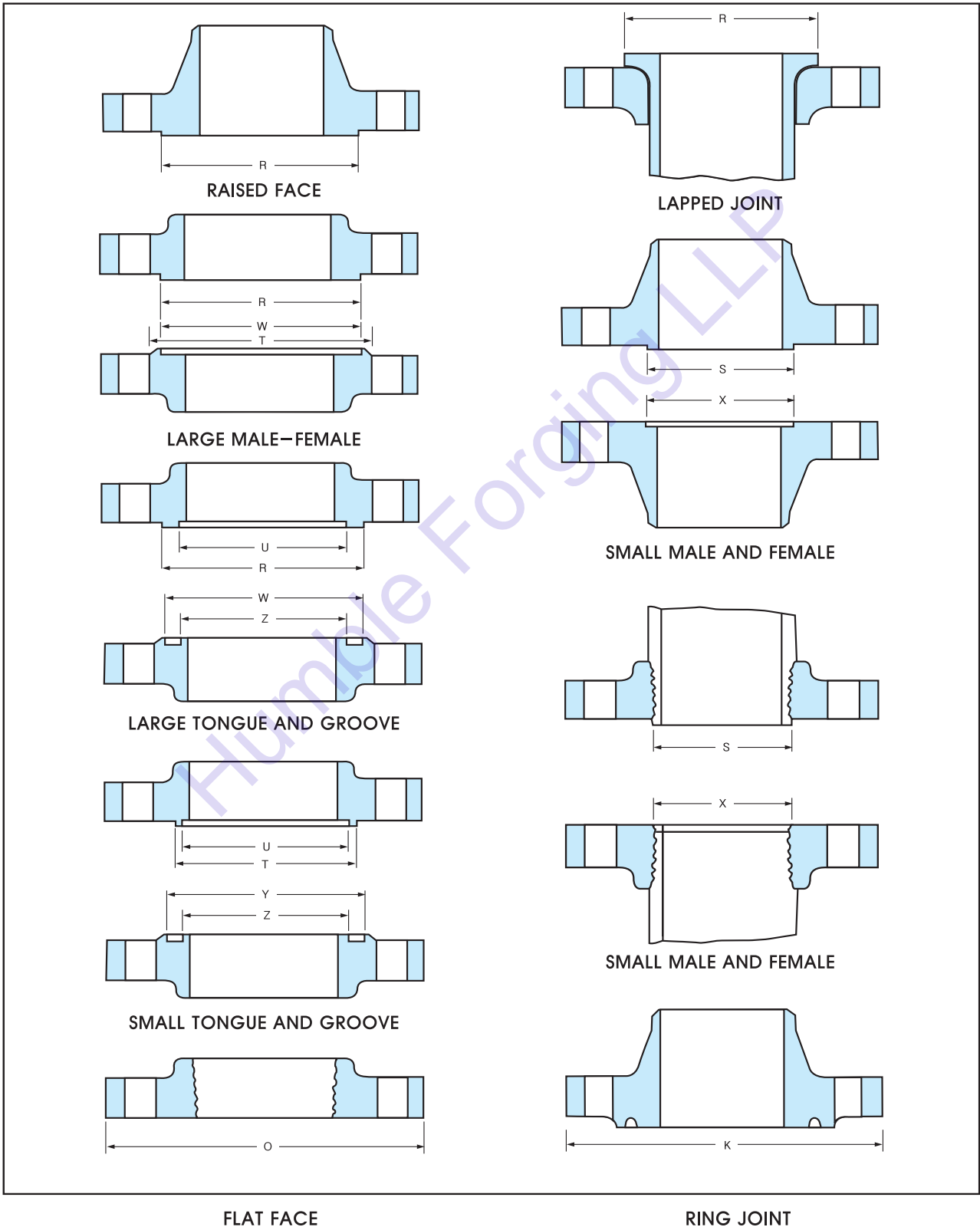



CLASS 150 & 300RF    CLASS 400 & UPWARD RF    MALE    FEMALE    THREADED MALE    THREADED FEMALE    TONGUE    GROOVE    RING JOINT

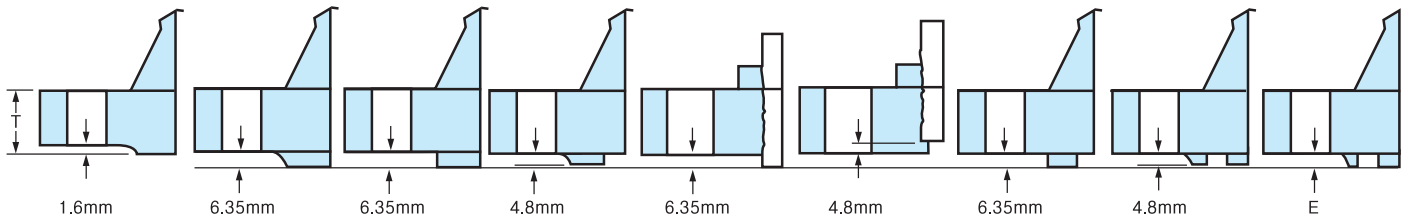

## ANSI B16.5 FORGED FLANGES

Unit : mm

Nominal Pipe Size	OUTSIDE DIAMETER				OUTSIDE DIAMETER				I.D. of Large and Groove	HEIGHT		Depth of Groove or Female
	Raised Face, Lapped Large Male and Large Tongue	Small Male	Small Tongue	I.D. of Lager and Small Tongue	Large Female and Large Groove		Small Female	Small Groove		Raised Face, and 300 ST' DS	Raised Face, Large and Small Male and Tongue Classes 400 2500 ST' DS	
					R	S						
1/2	35.1	18.3	35.1	25.4	36.6	46.0	19.8	36.6	23.9	1.5	6.4	4.8
3/4	42.9	23.9	42.9	33.3	44.5	53.8	25.4	44.5	31.8	1.5	6.4	4.8
1	50.8	30.2	47.8	38.1	52.3	62.0	31.8	49.3	36.6	1.5	6.4	4.8
1 1/4	63.5	38.1	57.2	47.8	65.0	74.7	39.6	58.7	46.0	1.5	6.4	4.8
1 1/2	73.2	44.5	63.5	53.8	74.7	84.1	46.0	65.0	52.3	1.5	6.4	4.8
2	91.9	57.2	82.6	73.2	93.7	103.1	58.7	84.1	71.4	1.5	6.4	4.8
2 1/2	104.6	68.3	95.3	85.9	106.4	115.8	69.9	96.8	84.1	1.5	6.4	4.8
3	127.0	84.1	117.3	108.0	128.5	138.2	85.9	119.1	106.4	1.5	6.4	4.8
3 1/2	139.7	96.8	130.0	120.7	141.2	150.9	98.6	131.8	119.1	1.5	6.4	4.8
4	157.2	109.5	144.5	131.8	158.8	168.1	111.3	146.1	130.0	1.5	6.4	4.8
5	185.7	136.7	173.0	160.3	187.5	196.9	138.2	174.8	158.8	1.5	6.4	4.8
6	215.9	162.1	203.2	190.5	217.4	227.1	163.6	204.7	189.0	1.5	6.4	4.8
8	269.7	212.9	254.0	238.3	271.5	280.9	214.4	255.5	236.5	1.5	6.4	4.8
10	323.9	266.7	304.8	285.8	325.4	335.0	268.2	306.3	284.2	1.5	6.4	4.8
12	381.0	317.5	362.0	342.9	382.5	392.2	319.0	363.5	341.4	1.5	6.4	4.8
14	412.8	349.3	393.7	374.7	414.3	423.9	350.8	395.2	373.1	1.5	6.4	4.8
16	469.9	400.1	447.5	425.5	471.4	481.1	401.6	449.3	423.9	1.5	6.4	4.8
18	533.4	450.9	511.0	489.0	534.9	544.6	452.4	512.8	487.4	1.5	6.4	4.8
20	584.2	501.7	558.8	533.4	585.7	595.4	503.2	560.3	531.9	1.5	6.4	4.8
24	692.2	603.3	666.8	641.4	693.7	703.3	604.8	668.3	639.8	1.5	6.4	4.8

**Notes:**

- (1) Small male and female faces are not applicable to Slip-on Flange.
- (2) Large male and female faces are not applicable to Class 150 Flanges.
- (3) For flanges of Class 150 and 300 where they are to be bolted to ANSI Class 125 and 250 Cast-Iron Flanges or required with flat face, flat face can be made by removing raised face.

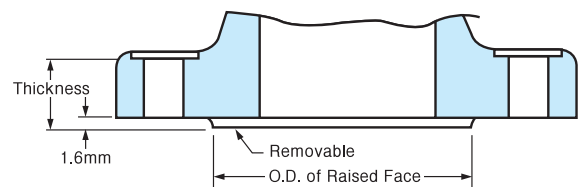

- Tolerances are  $\pm 0.03"$  (+0.8mm) for 0.06" (1.6mm) RF and  $\pm 0.02"$  (+0.5mm) for 0.25" (6.35mm) RF Large Male and Large Tongue.



## THREAD DETAILS

### THREAD AND STANDARDS FOR ANSI FLANGES (ANSI B2.1)

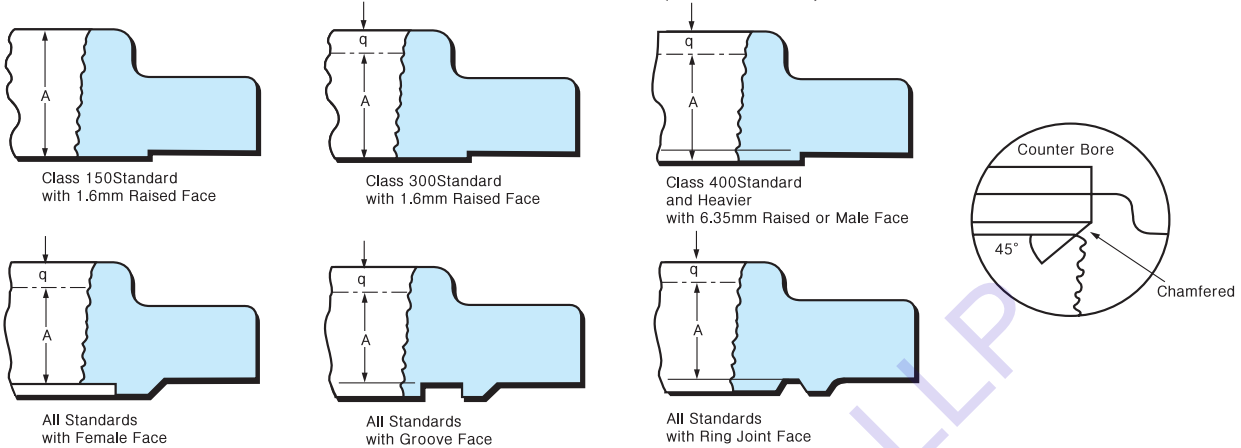

### ANSI B16.5 FORGED FLANGES

Unit : mm

Nominal Pipe Size	A – THREAD LENGTHS						
	Class 150	Class 300	Class 400	Class 600	Class 900	Class 1500	Class 2500
1/2	15.9	15.9	15.9	15.9	22.2	22.2	28.6
3/4	15.9	15.9	15.9	15.9	25.4	25.4	31.8
1	17.5	17.5	17.5	17.5	28.6	28.6	34.9
1 1/4	20.7	20.7	20.7	20.7	30.2	30.2	38.1
1 1/2	22.2	22.2	22.2	22.2	31.8	31.8	44.5
2	25.4	28.6	28.6	28.6	38.1	38.1	50.8
2 1/2	28.6	31.8	31.8	31.8	47.6	47.6	57.2
3	30.1	31.8	34.9	34.9	41.3	50.8	63.5
3 1/2	31.8	36.5	39.7	39.7			
4	33.4	36.5	36.5	41.3	47.6	57.2	69.9
5	36.5	42.9	42.9	47.6	54.0	63.5	76.2
6	39.7	46.1	46.1	50.8	57.2	69.9	82.6
8	44.5	50.8	50.8	60.3	63.5	76.2	95.3
10	49.2	55.6	55.6	65.1	71.5	84.2	108.0
12	55.6	60.3	60.3	69.9	76.2	92.1	120.7
14	57.2	63.5	63.5	73.0	82.6		
16	63.5	68.3	68.3	77.8	85.7		
18	68.3	69.9	69.9	78.4	88.9		
20	69.9	73.0	73.0	82.6	92.1		
24	82.6	82.6	82.6	92.1	101.6		

#### Notes:

- (1) Except flanges with Small Male/Female Face (on pipe end), threaded flanges, have an American National Standard taper pipe thread conforming to ANSI B2.1.
- (2) The thread is concentric with the axis of the flange and variations in alignment do not exceed 0.06(1.6mm) in. per foot (0.5 percent)
- (3) Class 150 flanges are made without counterbore. The threads are chamfered approximately to the major diameter of the thread at the back of the flange at an angle of approximately 45 degrees with the axis of thread. The chamfer is concentric with the thread and included in the measurement of the thread length.
- (4) Class 300 and higher pressure flanges are made with a counterbore at the back of the flange. The threads are chamfered to the diameter of the counterbore at an angle of approximately 45 degrees with the axis of the thread. The counterbore and chamfer are concentric with the thread.
- (5) The minimum length of effective thread in reducing flanges is at least equal to dimension Q of the corresponding class of threaded flange as shown in the above tables. Threads do not necessarily extend to the face to the flange.



## PIPE DIMENSIONS

### WELDED AND SEAMLESS PIPE CARBON AND ALLOY STEELS

#### ANSI B36.10

Unit : mm

Nominal Pipe		Outside Diam	I.D Wall	Nominal Inside diameter and Wall thickness													
Inch (B)	mm (DN)			Sch. 5	Sch. 10	Sch. 20	Sch. 30	STD	Sch. 40	Sch. 60	Sch. XS	Sch. 80	Sch. 100	Sch. 120	Sch. 140	Sch. 160	Sch. XXS
1/8	6	10.3	I.D		7.8		7.4	6.8	6.8		5.5	5.5					
			Wall		1.2		1.5	1.7	1.7		2.4	2.4					
1/4	8	13.7	I.D		10.4		10.0	9.2	9.2		7.7	7.7					
			Wall		1.7		1.9	2.2	2.2		3.0	3.0					
3/8	10	17.1	I.D		13.8		13.4	12.5	12.5		10.7	10.7					
			Wall		1.7		1.9	2.3	2.3		3.2	3.2					
1/2	15	21.3	I.D	18.0	17.1		16.5	15.8	15.8		13.8	13.8				11.7	6.4
			Wall	1.7	2.1		2.4	2.8	2.8		3.7	3.7					4.8
3/4	20	26.7	I.D	23.4	22.5		21.9	21.0	21.0		18.9	18.9				15.6	11.1
			Wall	1.7	2.1		2.4	2.9	2.9		3.9	3.9					5.6
1	25	33.4	I.D	30.1	27.9		27.6	26.6	26.6		24.3	24.3				20.7	15.2
			Wall	1.7	2.8		2.9	3.4	3.4		4.6	4.6					6.4
1 1/4	32	42.2	I.D	38.9	36.7		36.3	35.1	35.1		32.5	32.5				29.5	22.8
			Wall	1.7	2.8		3.0	3.6	3.6		4.9	4.9					6.4
1 1/2	40	48.3	I.D	45.0	42.8		41.9	40.9	40.9		38.1	38.1				34.0	28.0
			Wall	1.7	2.8		3.2	3.7	3.7		5.1	5.1					7.1
2	50	60.3	I.D	57.0	54.8		53.9	52.5	52.5		49.2	49.2				42.8	38.2
			Wall	1.7	2.8		3.2	3.9	3.9		5.5	5.5					8.7
2 1/2	65	73.0	I.D	68.8	66.9		63.4	62.7	62.7		59.0	59.0				53.9	45.0
			Wall	2.1	3.1		4.8	5.2	5.2		7.0	7.0					9.5
3	80	88.9	I.D	84.7	82.8		79.3	77.9	77.9		73.7	73.7				66.6	58.4
			Wall	2.1	3.1		4.8	5.5	5.5		7.6	7.6					11.1
3 1/2	90	101.6	I.D	97.4	95.5		92.0	90.1	90.1		85.4	85.4					
			Wall	2.1	3.1		4.8	5.7	5.7		8.1	8.1					
4	100	114.3	I.D	110.1	108.2		104.7	102.3	102.3		97.2	97.2		92.0		87.3	80.1
			Wall	2.1	3.1		4.8	6.0	6.0		8.6	8.6		11.1		13.5	17.1
5	125	141.3	I.D	135.8	134.5			128.2	128.2		122.2	122.2		115.9		109.5	103.2
			Wall	2.8	3.4			6.6	6.6		9.5	9.5		12.7		15.9	19.1
6	150	168.3	I.D	162.8	161.5			154.1	154.1		146.4	146.4		139.8		131.8	124.4
			Wall	2.8	3.4			7.1	7.1		11.0	11.0		14.3		18.3	22.0
8	200	219.1	I.D	213.6	211.6	206.4	205.0	202.7	202.7	198.5	193.7	193.7	188.9	182.6	177.9	173.1	174.6
			Wall	2.8	3.8	6.4	7.0	8.2	8.2	10.3	12.7	12.7	15.1	18.3	20.6	23.0	22.2
10	250	273.0	I.D	266.2	264.6	260.3	257.4	254.5	254.5	247.6	247.6	242.8	236.5	230.1	222.2	215.8	222.2
			Wall	3.4	4.2	6.4	7.8	9.3	9.3	12.7	12.7	15.1	18.3	21.4	25.4	28.6	25.4
12	300	323.8	I.D	315.9	314.7	311.1	307.0	304.7	303.2	295.3	298.4	288.8	280.9	273.0	266.6	257.2	273.0
			Wall	4.0	4.6	6.4	8.4	9.5	10.3	14.3	12.7	17.5	21.4	25.4	28.6	33.3	25.4
14	350	355.6	I.D	347.7	342.9	339.8	336.5	336.5	333.3	325.4	330.2	317.5	307.9	300.0	292.1	284.2	
			Wall	4.0	3.7	7.9	9.5	9.5	11.1	15.1	12.7	19.1	23.8	27.8	31.8	35.7	
16	400	406.4	I.D	398.0	393.7	390.6	387.3	387.3	381.0	373.1	381.0	363.5	354.0	344.5	333.3	325.4	
			Wall	4.2	6.4	7.9	9.5	9.5	12.7	16.7	12.7	21.4	26.2	31.0	36.5	40.5	
18	450	457.0	I.D	448.6	444.3	441.2	434.7	437.9	428.5	418.9	431.6	409.3	398.3	387.1	377.7	366.5	
			Wall	4.2	6.4	7.9	11.1	9.5	14.3	19.1	12.7	23.8	29.4	34.9	39.7	45.2	
20	500	508.0	I.D	498.4	495.3	488.9	482.6	488.9	477.8	466.8	482.6	455.6	442.9	431.8	419.1	408.0	
			Wall	4.8	6.4	9.5	12.7	9.5	15.1	20.6	12.7	26.2	32.5	38.1	44.5	50.0	
22	550	559.0	I.D	549.4	546.3	539.9	533.6	539.9		514.5	533.6	501.8	489.1	476.4	463.7	451.0	
			Wall	4.8	6.4	9.5	12.7	9.5		22.2	12.7	28.6	34.9	41.3	47.6	54.0	
24	600	610.0	I.D	598.9	597.3	590.9	581.5	590.9	575.0	560.8	584.6	548.1	532.2	518.0	505.3	490.9	
			Wall	5.5	6.4	9.5	14.3	9.5	17.5	24.6	12.7	31.0	38.9	46.0	52.4	59.5	

#### ► Not included B36.10

The wall thickness shown represent nominal wall dimensions which are subject to a-12 1/2% mill tolerance.

Note that schedule 40 in, size 12" (304.8mm) and larger and that schedule 80 in, size 10" (254mm) and larger do not agree with schedules 40S and 80S of ANSI B36. 19 nor with standard weight and extra strong respectively.





## WELDED AND SEAMLESS PIPE STAINLESS STEELS

### ANSI B36.19

Unit : mm

Nominal Pipe Size		Outside Diam	I.D Wall	Nominal Inside diameter and Wall thickness			
Inch (B)	mm (DN)			Sch. 5S	Sch. 10S	Sch. 40S	Sch. 80S
1/8	6	10.3	I.D		7.8	6.8	5.5
			Wall		1.2	1.7	2.4
1/4	8	13.7	I.D		10.4	9.2	7.7
			Wall		1.7	2.2	3.0
3/8	10	17.1	I.D		13.8	12.5	10.7
			Wall		1.7	2.3	3.2
1/2	15	21.3	I.D	18.0	17.1	15.8	13.8
			Wall	1.7	2.1	2.8	3.7
3/4	20	26.7	I.D	23.4	22.5	21.0	18.9
			Wall	1.7	2.1	2.9	3.9
1	25	33.4	I.D	30.1	27.9	26.6	24.3
			Wall	1.7	2.8	3.4	4.6
1 1/4	32	42.2	I.D	38.9	36.7	35.1	32.5
			Wall	1.7	2.8	3.6	4.9
1 1/2	40	48.3	I.D	45.0	42.8	40.9	38.1
			Wall	1.7	2.8	3.7	5.1
2	50	60.3	I.D	57.0	54.8	52.5	49.2
			Wall	1.7	2.8	3.9	5.5
2 1/2	65	73.0	I.D	68.8	66.9	62.7	59.0
			Wall	2.1	3.1	5.2	7.0
3	80	88.9	I.D	84.7	82.8	77.9	73.7
			Wall	2.1	3.1	5.5	7.6
3 1/2	90	101.6	I.D	97.4	95.5	90.1	85.4
			Wall	2.1	3.1	5.7	8.1
4	100	114.3	I.D	110.1	108.2	102.3	97.2
			Wall	2.1	3.1	6.0	8.6
5	125	141.3	I.D	135.8	134.5	128.2	122.2
			Wall	2.8	3.4	6.6	9.5
6	150	168.3	I.D	162.8	161.5	154.1	146.4
			Wall	2.8	3.4	7.1	11.0
8	200	219.1	I.D	213.6	211.6	202.7	193.7
			Wall	2.8	3.8	8.2	12.7
10	250	273.0	I.D	266.2	264.7	254.6	247.7
			Wall	3.4	4.2	9.3	12.7
12	300	323.8	I.D	315.9	317.8	304.8	298.5
			Wall	4.0	4.6	9.5	12.7
14	350	355.6	I.D	347.7	346.0		
			Wall	4.0	4.8		
16	400	406.4	I.D	398.0	396.8		
			Wall	4.2	4.8		
18	450	457.0	I.D	448.6	447.4		
			Wall	4.2	4.8		
20	500	508.0	I.D	498.4	496.9		
			Wall	4.8	5.5		
22	550	559.0	I.D	549.4	547.9		
			Wall	4.8	5.5		
24	600	610.0	I.D	598.9	597.3		
			Wall	5.5	6.35		

The wall thickness shown represent nominal or average wall dimensions which are subject to a -12 1/2% mill tolerance. Sizes 14" (355.6mm) through 30" (762.0mm) are not at publication date covered in B36.19, and dimensions listed are those commonly used in the industry.

\*Schedules 5S and 10S wall thicknesses do not permit threading in accordance with ANSI B2.1.

\*Note that schedule 40S and schedule 80S in these size do not agree with schedule 40 and schedule 80 of ANSI B36.10. and that they are identical to standard weight and extra strong respectively of ANSI B36.10.



## MATERIAL GRADE

GRADE	COMPOSITION										UNS NO.	DIN	Tensile Strength	Yield Strength	Brinell
	C	Mn	P	S	Si	Ni	Cr	Mo	N	V			Min, ksi(MPa)	Min, ksi(MPa)	Hardness
<b>LOW ALLOY STEELS</b>															
F1	0.28	0.06-0.90	0.045	0.045	0.15-0.35			0.44-0.65			K12822	15Mo3	70(485)	40(275)	143-192
F5	0.15	0.30-0.60	0.03	0.03	0.5	0.5	4.0-6.0	0.44-0.65			K41545	12CrMo19-5	70(485)	40(275)	143-217
F9	0.15	0.30-0.60	0.03	0.03	0.50-1.10		8.0-10.0	0.90-1.10			K90941	12-CrMo9-1	85(585)	55(380)	179-217
F91	0.08-0.12	0.30-0.60	0.02	0.01	0.20-0.50	0.4	8.0-9.5	0.85-1.05			K90901	X10CrMoN69-1	85(585)	60(415)	248max
F92	0.07-0.13	0.30-0.60	0.02	0.01	0.5	0.4	8.50-9.50	0.30-0.60					90(620)	64(440)	269max
F11	0.05-0.15	0.30-0.60	0.03	0.03	0.50-1.00		1.00-1.50	0.44-0.65			K11597	13CrMo44	60(615)	30(205)	121-174
F12	0.05-0.15	0.30-0.60	0.045	0.045	0.50		0.80-1.25	0.44-0.65			K11562	16CrMo44	60(415)	32(220)	121-174
F22	0.05-0.15	0.30-0.60	0.04	0.04	0.5		2.00-2.50	0.87-1.13			K21590	10CrMo9-10	60(415)	30(205)	170max
F23	0.04-0.10	0.10-0.60	0.03	0.01	0.5		1.92-2.60	0.05-0.30			K41650		74(510)	58(400)	220max
SCM440	0.38-0.43	0.60-0.90	0.03	0.03	0.15-0.35	0.25	0.90-1.20	0.15-0.30				42CrMo4			
SNCM439	0.36-0.43	0.60-0.90	0.03	0.03	0.15-0.35	1.60-2.00	0.60-1.00	0.15-0.30				36CrNiMo4			
<b>STAINLESS STEELS (MARTENSITIC)</b>															
F6	0.15	1	0.04	0.03	1	0.5	11.5-13.5				S41000	X12Cr13	70(485)	40(275)	143-207
<b>STAINLESS STEELS (FERRITIC)</b>															
F429	0.12	1	0.04	0.03	0.75	0.5	14.0-16.0				S42900		60(415)	35(240)	190max
F430	0.12	1	0.04	0.03	0.75	0.5	16.0-18.0				S43000		60(415)	35(240)	190max
<b>STAINLESS STEELS(AUSTENITIC)</b>															
F304L	0.03	2	0.045	0.03	1	8.0-13.0	18.0-20.0				S30403	X2CrNi19-11	70(485)	25(170)	
F310	0.25	2	0.045	0.03	1	19.0-22.0	24.0-26.0				S31000	X12CrNi25-20	75(515)	30(205)	
F316L	0.03	2	0.045	0.03	1	10.0-15.0	16.0-18.0	2.0-3.0			S31603	X2CrNiMo18-14-3	70(485)	25(170)	
F317L	0.03	2	0.045	0.03	1	11.0-15.0	18.0-20.0	3.0-4.0			S31703		70(485)	25(170)	
F321	0.08	2	0.045	0.03	1	9.0-12.0	17.0-19.0				S32100	X6CrNiTi18-10	75(515)	30(205)	
F347	0.08	2	0.045	0.03	1	9.0-13.0	17.0-20.0				S34700	X6CrNiNb18-10	75(515)	30(205)	
F44	0.02	1	0.03	0.01	0.8	17.5-18.5	19.5-20.5	6.0-6.5			S31254		94(650)	44(300)	
<b>STAINLESS STEELS (DUPLEX)</b>															
F51	0.03	2	0.03	0.02	1	4.5-6.5	21.0-23.0	2.5-3.5			S31803	X2CrNiMoN22-5-3	90(620)	65(450)	
F53	0.03	1.2	0.035	0.02	0.8	6.8-8.0	24.0-26.0	3.0-5.0			S32750	X2CrNiMoCuWN25-7-4	116(800)	80(550)	310max
F904L	0.02	2	0.04	0.03	1	23.0-28.0	19.0-23.0	4.0-5.0			NO8904		71(490)	31(215)	
SUSF329J3L	0.03	2.0	0.04	0.030	1.00	4.50-6.50	21.0-24.0	2.50-3.50	0.08-0.20						
F60											S32205				
<b>CARBON STEELS</b>															
A105	0.35	0.60-1.05	0.035	0.04	0.10-0.35	0.4	0.3	0.12				CK25	70(485)	36(250)	187
A350LF2	0.3	0.60-1.35	0.035	0.04	0.15-0.30	0.4	0.3	0.12					70-95 (485-655)	36(250)	197
A350LF3	0.2	0.9	0.035	0.04	0.20-0.35	3.3-3.7	0.3	0.12					70-95 (485-655)	37.5(260)	
A694/F65	0.26	1.4	0.025	0.025	0.15-0.35								77(530)	65(450)	
S45C	0.42-0.48	0.60-0.90	0.30	0.35	0.15-0.35							CK45			
<b>ALLOY STEELS</b>															
ALLOY20	0.07	2	0.45	0.35	1	32-38	19-21	2.0-3.0			NO8020				
ALLOY625	0.1	0.5	0.015	0.015	0.5	58	20-23	8.0-10.0			NO6625				
ALLOY800	0.1	1.5		0.015	1	30-35	19-23				NO8800				
A800H/HT	0.05-0.10	1.5		0.015	1	30-35	19-23				NO8810/11				
ALLOY825	0.05	1		0.03	0.5	38-46	19.5-23.5	2.50-3.50			NO8825				



## MATERIAL SPECIFICATIONS

### APPLICABLE ASTM SPECIFICATIONS

Material Group No.	GROUP 1 MATERIALS			PRODUCT FORMS			
	Normal Designation Steel	Forgings Spec. -Gr.	Notes	Castings Spec. -Gr.	Notes	Forgings Spec. -Gr.	Notes
1.1	Carbon	A105 A350-LF2	(1)(3)	A216-WCB	(1)	A515-70 A516-70 A537-C1.1	(1) (1)
	C-Mn-Si						
1.2	Carbon			A216-WCC A352-LCC	(1)		
	2-1/2 Ni 3-1/2 Ni	A350-LF3		A352-LC2 A352-LC3		A203-B A302-E	
1.3	Carbon			A352-LCB	(1)	A203-A A203-D A515-65 A516-65	
1.4	Carbon	A350-LF1				A515-60 A516-60	(1)
1.5	C-1/2 Mo	A182-F1	(2)	A217-WC1 A352-LC1	(2)(4)	A204-A A204-B A204-C	(2) (2) (2)
1.7	C-1/2 Mo 1/2 Cr-1/2 Mo	A182-F2					
	Ni-Cr-1/2 Mo Ni-Cr-1 Mo			A217-WC4 A217-WC5	(4) (4)		
1.9	1 Cr-1/2 Mo 1-1/4 Cr-1/2 Mo	A182-F12 A182-F11	(4) (4)				
	2-1/4 Cr-1 Mo	A182-F22		A217-WC6 A217-WC9	(4) (4)	A387-11 C1.2 A387-22 C1.2	
1.10	5 Cr-1/2 Mo	A181-F5 A182-F5a		A217-C5	(4)		
1.13	9 Cr-1 Mo	A182-F9		A217-C12	(4)		
GROUP 2 MATERIALS			PRODUCT FORMS				
2.1	18 Cr-8 Ni	A182-F304	(5)	A351-CF3		A240-304	(5)(6)
	18 Cr-8 Ni	A182-F304H		A351-CF8	(5)	A240-304H	
2.2	16 Cr-12 Ni-2 Mo	A182-F316 A182-F316H	(5)			A240-316 A240-316H	(5)(6)
	18 Cr-13 Ni-3 Mo 18 Cr-9 Ni-2 Mo			A351-CF3M A351-CF8M	(5)	A240-317	(5)(6)
2.3	18 Cr-8 Ni 16 Cr-12 Ni-2 Mo	A182-F304L A182-F316L				A240-304L A240-316L	
2.4	18 Cr-10 Ni-Ti	A182-F321 A182-F321H	(5)			A240-321 A240-321H	(5)(6)
2.5	18 Cr-10 Ni-Cb	A182-F347 A182-F347H A182-F348 A182-F348H	(5)	A351-CF8C	(5)	A240-347 A240-347H A240-348 A240-348H	(5)(6) (5)(6)
	25 Cr-12 Ni			A351-CH8 A351-CH20	(5) (5)		
2.6	23 Cr-12 Ni					A240-309S	(5)(6)
	25 Cr-20 Ni	A182-F310	(5)(7)	A351-CK20	(5)	A240-310S	(5)(6)(7)

#### General Notes:

- For temperature limitations see footnotes in ANSI B16.5 TABLES. (PRESSURE-TEMPERATURE RATINGS)
- Plate materials are listed only for use as blind flanges (see 5.1). Additional plate materials listed in ANSI B16.34 may also be used, with corresponding B16.34 Standard Class ratings.
- Material Groups not listed in Table 1A are intended for use in valves. See ANSI B16.34.

#### Notes:

- Upon prolonged exposure to temperatures above about 800°F (425°C), the carbide phase of carbon steel may be converted to graphite.
- Upon prolonged exposure to temperatures above about 875°F (470°C), the carbide phase of carbon-molybdenum steel may be converted to graphite.
- Only killed steel shall be used above 850°F (455°C).
- Use normalized and tempered material only.
- At temperatures over 1000°F (540°C), use only when the carbon content is 0.04 percent or higher.
- For temperatures above 1000°F (540°C), use only if the material is heat treated by heating it to a temperature of at least 1900°F (1040°C) and quenching in water or rapidly cooling by other means.



## WELDING ENDS

### ANSI B16.5 FORGED FLANGES

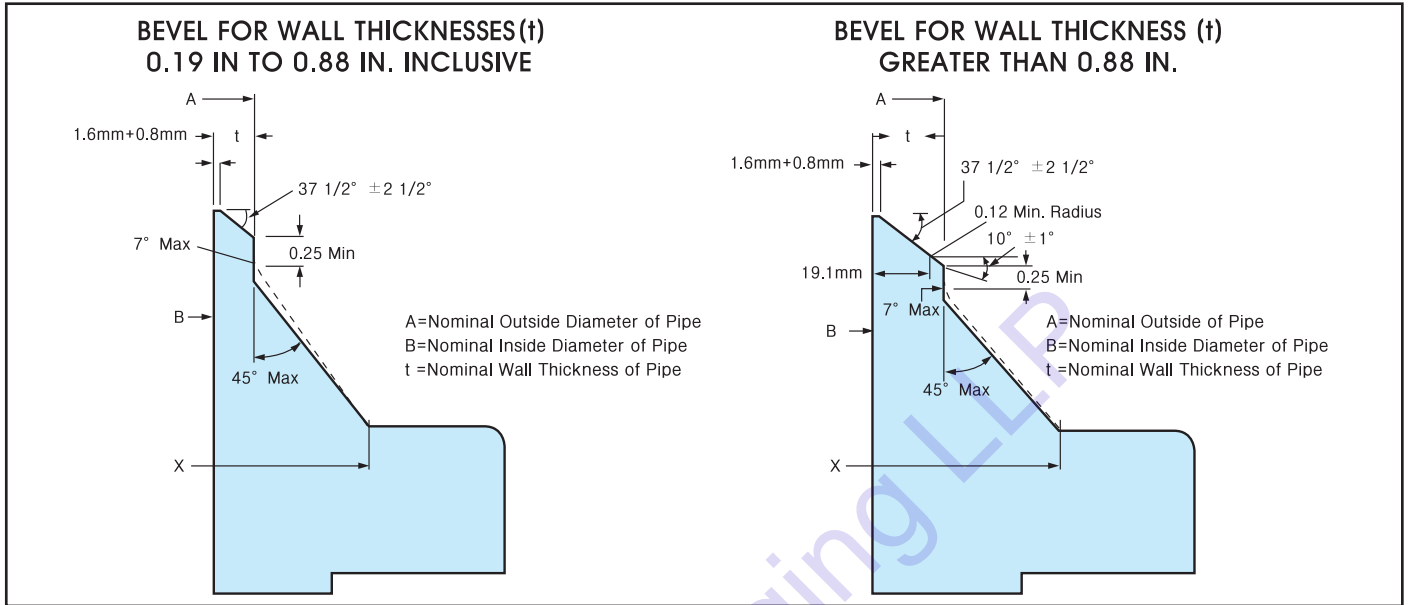

**Notes:**

When the thickness of the hub at the bevel is greater than that of the pipe to which the flange is joined and the additional thickness is provided on the outside diameter, a taper weld having a slope not exceeding 1 to 3 may be employed or, alternatively, the greater outside diameter may be tapered, at the same maximum slope or less, from a point on the welding bevel equal to the OD at the mating pipe. Similarly, when the greater thickness is provided on the inside of the flange, it shall be taper-bored from the welding end at a slope not exceeding 1 to 3.

When flanges covered by this standard are intended for services with light wall, higher strength pipe, the thickness of the hub at the bevel may be greater than that of the pipe to which the flange is joined. Under these conditions a single taper hub may be provided and the outside diameter of the hub at the base (Dimension X) may also be modified.

The additional thickness may be provided on either inside or outside or partially on each side, but the total additional thickness shall not exceed one-half times the nominal wall thickness of intended mating pipe.

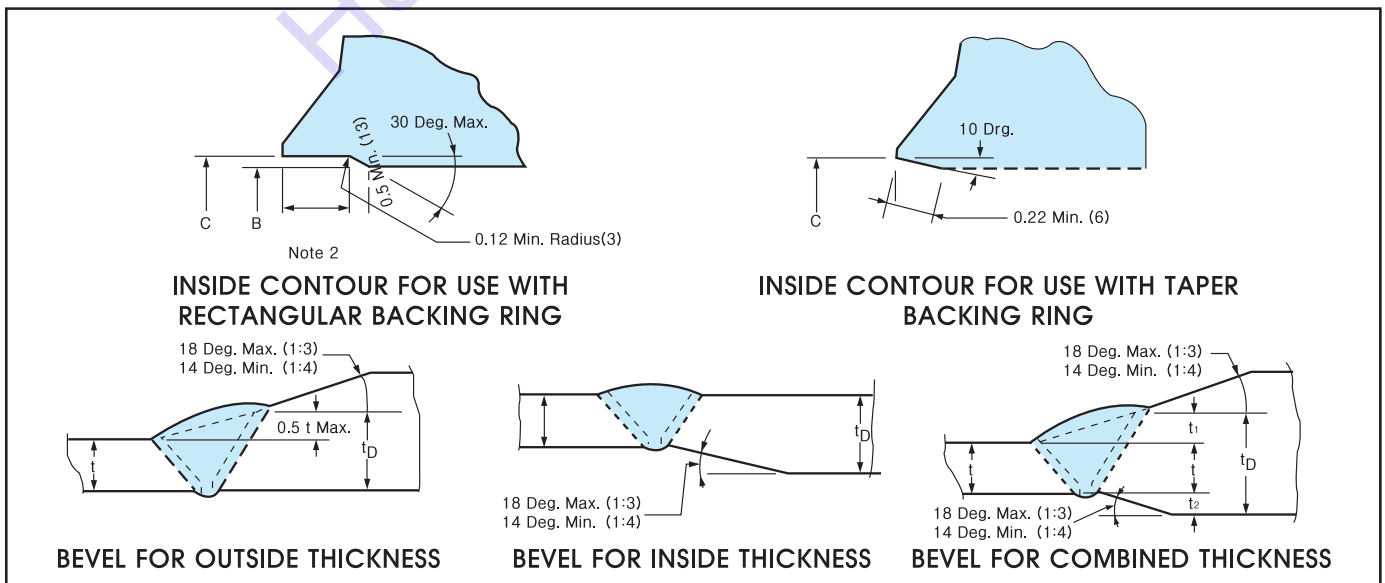





# Contact Us

Tel: +91-9004100263

Email: [info@humbleforging.com](mailto:info@humbleforging.com)

Web: [www.humbleforging.com](http://www.humbleforging.com)

